

HENDERSON WHEEL & WAREHOUSE SUPPLY

2008 HEAVY DUTY STEEL TRUCK WHEEL CATALOG

October 2008

Eight Hole Wheels	Page 3
Ten Hole Budd Uni-Mount-10 Type Wheels	Page 4
Six Hole Wheels	Page 5
17.5" Ten Hole Wheel	Page 6
22.5" Budd Type Wheels	Page 7
22.5" x 9" Budd Type Wheels	Page 8
22.5" Duplex Wheels	Pages 9 - 11
24.5" Budd Type Wheels	Page 12
Chevrolet & GMC Wheels	Pages 13 - 14
Ford 1-Ton 19.5" Wheels	Page 15
Heavy Duty Nuts & Lug Nut Covers	Pages 16 - 18
Wheel Guards	Page 19
Demountable Rims	Page 20 - 21
Demountable Rims Nuts & Studs	Page 22
Spacer Bands	Page 23
Lock Rings	Pages 24 - 26



**PRACTICE WHEEL AND RIM SAFETY
AVOID A THREAT TO LIFE AND LIMB**

- **Don't work on a rim or wheel assembly until you understand safety warnings and manufacturers' instructions.**
- **Don't mismatch rim parts.**
- **Scrap cracked, worn, rusted or distorted components.**
- **Inspect wheels and rims for wear and defects at every tire de-mounting.**

For safety information, please call or write Henderson Wheel.



**Eight Hole, 275 mm Bolt Circle
 Motor Wheel WHD-8 Type Wheel
 Hub-Piloted Dual Mounting
 Single Two-Piece Washered Nut (E5991)**

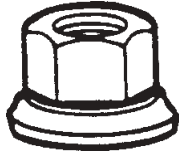

Part No.	Thread	Hex	Description
E5991	M22 x 1.5	1-1/2"	Single Two-Piece Washered Nut



Hug-A-Lug Nut Cover	Part No.	Fits
1-1/2" Hex for Motor Wheel WHD-8 Type Nut	000182	1-1/2" Hex



Wheel Size	Tire Sizes	Part No.	Comments
17.5" x 6.75"	9.00	F28656	Grey Wheel Four Hand Hole Capacity 5355 # Center Bore: 221 mm
19.5" x 6.75"	8.00	F50180	Grey Wheel Four Hand Hole Capacity 5000 # Center Bore: 221 mm
22.5" x 8.25"	11.00	F28484W	White Wheel Four Hand Hole Capacity 7300 # Center Bore: 221 mm
24.5" x 8.25" (Special Order)	11.00, 285/75	89851E	White Wheel Four Hand Hole Capacity 7400 # Center Bore: 221.1 mm



**Ten Hole, 285.75 mm Bolt Circle
 Budd Uni-Mount-10 Type Wheel
 Hub-Piloted Dual Mounting, 220 mm Center Bore
 Single Two-Piece Washered Nut (E6000A)**

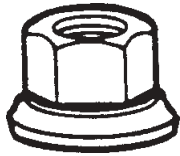

Part No.	Thread	Hex	Description
E6000A	M22 x 1.5	33 mm	Single Two-Piece Washered Nut



Hug-A-Lug Nut Cover	Part No.	Fits
33mm Hex for Budd Uni-Mount-10 Type Nut	000181	33mm Hex



Wheel Size	Tire Size	Part No.	Comments
22.5" x 8.25"	11.00	22408W or F50408W	White Wheel Two Hand Hole Capacity 7400 #
22.5" x 9" Single Wheel	12.00, 12.50, 12.75, 295/75, 305/70R, 315/80R	F29039	Grey Wheel Five Hand Hole Capacity 10,000 #
22.5" x 9" Dual Wheel	12.00, 12.50, 12.75, 295/75, 305/70R, 315/80R	F29300	Grey Wheel Five Hand Hole Capacity 9000 #
24.5" x 8.25"	11.00, 285/75	22409W or F28409W	White Wheel Two Hand Hole Capacity 7300 #





**Six Hole, 8-3/4" Bolt Circle, 6-1/2" Center Bore
Budd Type Double Cap Nut Wheel, Stud-Piloted Dual Mounting**

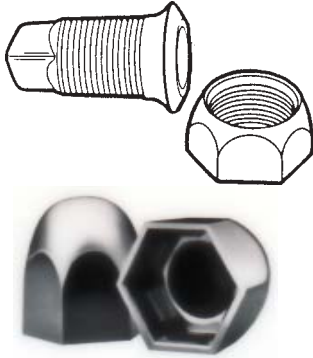

Part No.	Description
E7895-R & L	Inner 3/4" Cap Nut
E5977-R & L	Outer 1-1/8" Cap Nut
000150	Budd-Type Hug-A-Lug Nut Cover

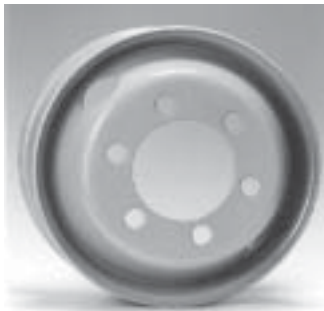

Wheel Size	Tire Size	Part No.	Comments
17.5" x 6.75"	9.00	F28145	Grey Wheel Two Hand Hole Low Boy Wheel Capacity 5070 # 15" Low Boy Wheel Replacement (If all Wheels Changed)
19.5" x 6" (Special Order)	8.00	F29388	Grey Wheel Two Hand Hole Capacity 3640 #
22.5" x 6.75"	9.00	F28157	Grey Wheel Six Hand Hole Capacity 4610 #



**Ten Hole, 8-3/4" Bolt Circle, 6-1/2" Center Bore
Budd Type Double Cap Nut Wheel, Stud-Piloted Dual Mounting**

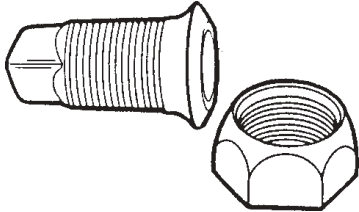

Part No.	Description
E7895-R & L	Inner 3/4" Cap Nut
E5977-R & L	Outer 1-1/8" Cap Nut



Part No.	Description	Fits
000150	Budd-Type Chrome Hug-A-Lug	1-1/2" Hex



Wheel Size	Tire Size	Part No.	Comments
17.5" x 6.75"	9.00	91834W (White Wheel)	Two Hand Hole Low Boy Wheel Capacity 5070 # (Replaces 15" Low Boy; if all wheels changed.)

**Ten Hole, 11-1/4" Bolt Circle, 8.72" Center Bore
Budd Type Double Cap Nut Wheel, Stud-Piloted Dual Mounting, Cont.**

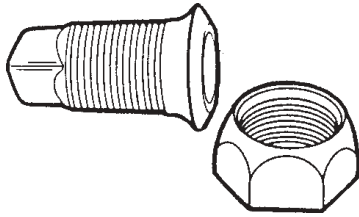

Part No.	Description
E7895-R & L	Inner 3/4" Cap Nut
E5977-R & L	Outer 1-1/8" Cap Nut



Part No.	Description	Fits
000150	Budd-Type Chrome Hug-A-Lug	1-1/2" Hex



Wheel Size	Tire Size	Part No.	Comments
22.5" x 7.5"	10.00	F27403	Grey Wheel Two Hand Hole Capacity 6610 #
22.5" x 8.25"	11.00	22404W or F27404W	White Wheel Two Hand Hole Capacity 7400 #



**Ten Hole, 11-1/4" Bolt Circle, 8.72" Center Bore
Budd Type Double Cap Nut Wheel, Stud-Piloted Dual Mounting, Cont.**

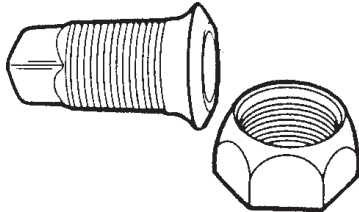

Part No.	Description
E7895-R & L	Inner 3/4" Cap Nut
E5977-R & L	Outer 1-1/8" Cap Nut



Part No.	Description	Fits
000150	Budd-Type Chrome Hug-A-Lug	1-1/2" Hex



Wheel Size	Tire Sizes	Part No.	Comments
22.5" X 9.00" (Dual Wheel)	12.00, 12.50 12.75, 295/75 305/70R, 315/80R	F28510(1)	Grey Wheel Steering Axle Single & Rear Dual Two Hand Hole Capacity 9000 #
(1) Because of the thicker disc, longer studs must be used. When longer studs are used, wheels with thinner discs cannot be used in a dual assembly because the inner cap nut can bottom out before the wheel is securely clamped.			
22.5" X 9.00" (Single Wheel)	12.00, 12.50 12.75, 295/75 305/70R	F28192	Grey Single Wheel Capacity 9000 #
(Special Order)	315/80R		

Front Duplex Wheel

Stud-Piloted Mounting / Outer Cap Nut

10 Hole, 11-1/4" Bolt Circle, 8.72" Center Bore

Tire: 15 x 22.5, 16.5 X 22.5, 385/65R X 22.5, 425/65R X 22.5

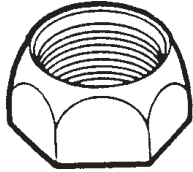

Part No.	Description
E5977-R & L	1-1/8" Outer Cap Nut

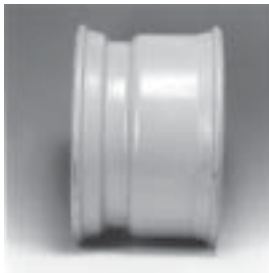

Wheel Size	Part No.	Wheel Picture	Wheel Capacity
22.5" x 12.25" (Special Order)	F29816	(1)	10,000 #

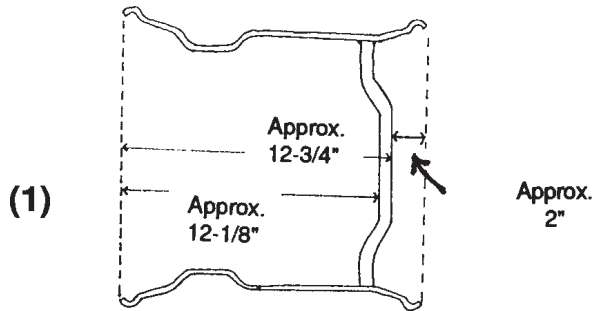

Normally a front Axle wheel.

Consider tire clearance when switching to duplex wheels.



Duplex Rear Wheel
Stud Piloted Mounting / Outer Cap Nut
10 Hole, 11-1/4" Bolt Circle, 8.72" Center Bore
Tire: 16.5 x 22.5, 18 x 22.5, 425/65R x 22.5, 445/65R x 22.5

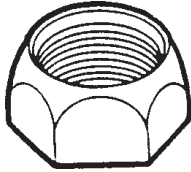

Part No.	Description
E5977-R & L	1-1/8" Outer Cap Nut

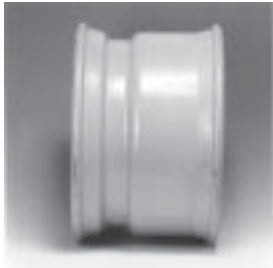

Wheel Size	Part No.	Wheel Picture	Wheel Capacity
22.5" x 13" (Special Order)	F29819	(2)	10,000 #

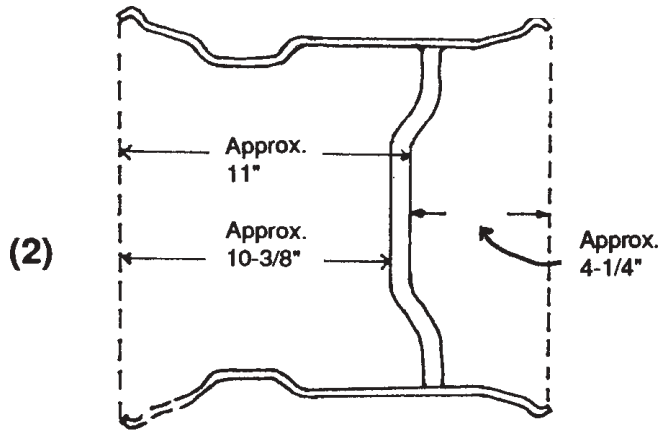

Normally replaces duals on drive (rear) and trailer axles.

Consider tire clearance when switching to duplex wheels.

Single Front Wide Wheel

Heavy Duty Stud-Piloted Mounting / Heavy Duty Outer Cap Nut

10 Hole, 13-3/16" Bolt Circle / 10.69" Center Bore

Tire: 16.5 x 22.5, 18 x 22.5, 425/65R x 22.5, 445/65R x 22.5

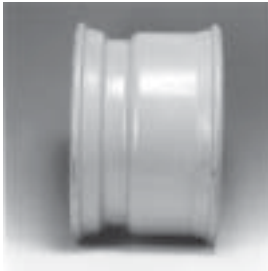

Wheel Size	Part No.	Wheel Picture	Wheel Capacity
22.5" x 13" (Special Order)	F28465	(3)	10,210 #

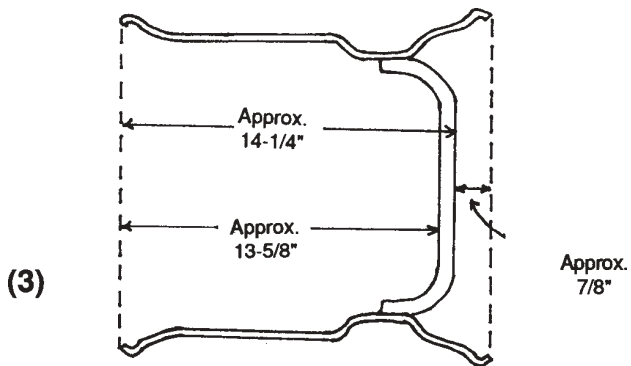

Always a front axle wheel.

Consider tire clearance when switching to duplex wheels.



**Ten Hole, 11-1/4" Bolt Circle, 8.72" Center Bore
Budd Type Double Cap Nut Wheel, Stud-Piloted Dual Mounting, Cont.**

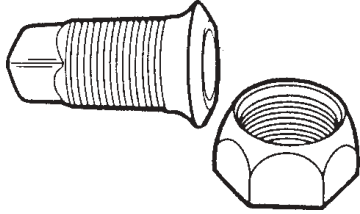

Part No.	Description
E7895-R & L	Inner 3/4" Cap Nut
E5977-R & L	Outer 1-1/8" Cap Nut



Part No.	Description	Fits
000150	Budd-Type Chrome Hug-A-Lug	1-1/2" Hex

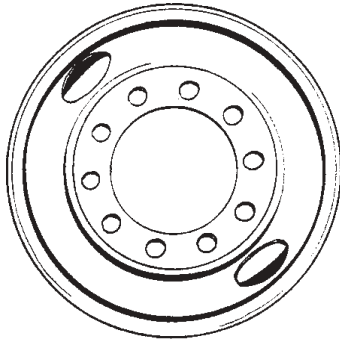

Wheel Size	Tire Size	Part No.	Comments
24.5" X 8.25"	11.00,	22406W	White Wheel
	285/75	or F27406W	Two Hand Hole Capacity 7300 #

Chevrolet and GMC 1 Ton 19.5" Wheels
Flat Face Wheels
Hub-Piloted Dual Mounting
Use Clamping Plate (8-Hole Plate, 722140) w/90 Degree Cone Nuts
Tire Size: 8.00

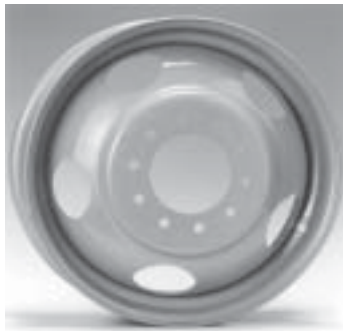

Wheel Size	Bolt Circle	Part No.	Comments
19.5" X 6.0" (Special Order)	8 - 6-1/2"	F29015	Capacity 2540 # Center Bore Size: 4.56" Four Hand Hole
19.5" x 6.0"	10 - 7-1/4"	F29667	Capacity 3000 # Center Bore Size: 5.25" Five Hand Hole



Chevrolet and GMC 1-1/2 to 2 Ton Wheels
Flat Face Wheels
Hub-Piloted Dual Mounting
Uses 11/16" Bell Nut
10 Hole, 8-3/4" Bolt Circle
6-1/4" Center Bore

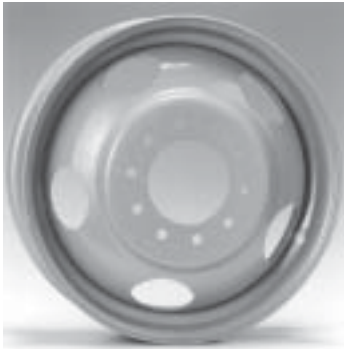

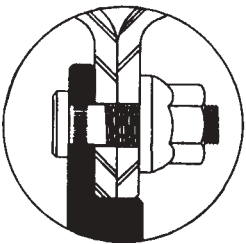
Wheel Size	Tire Size	Part No.	Comments
22.5" X 6.75"	<u>9.00</u>	F28160	Capacity 4675 # Five Hand Hole
<p>@ Uses E5734 or 11/16" Bell Nut</p> <div style="display: flex; align-items: center; justify-content: center;">  <div style="margin-left: 20px;"> <p>E5734 11/16" Bell Nut</p> </div> </div>			

Ford 1 Ton Dual Wheels
Hub-Piloted Dual Mounting
8 Hole, 225mm Bolt Circle
170.10mm Center Bore
2004-98

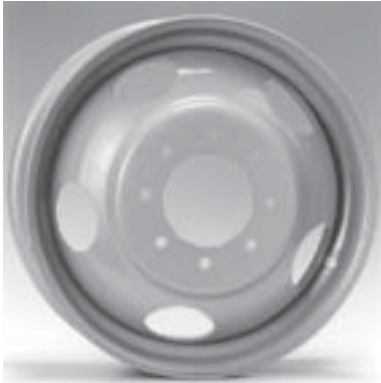

Wheel Size	Part No.	Comments
19.5" X 6.00"	F29584	Capacity 3750 # Five Hand Hole

Ford 1 Ton Dual Wheels
Hub-Piloted Dual Mounting
10 Hole, 225mm Bolt Circle
170.10mm Center Bore
2005

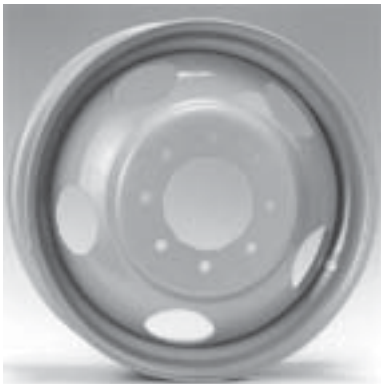

Wheel Size	Part No.	Comments
19.5" X 6.00RW"	F29884	Capacity 3750 # Five Hand Hole



**Heavy Duty Nuts
Steel Wheel Inner Nuts**

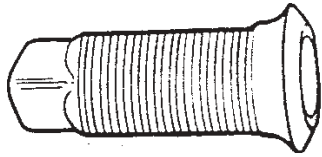
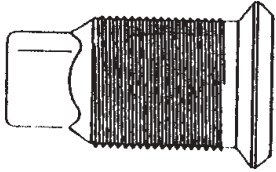

Part No.	Thread O.D.	Thread I.D.	O.A. Length	Application
E7895-R & L (Hardened)	1-1/8"-16	3/4"-16	2-7/32"	Steel Wheel Inner Nut
E7896-R & L (Hardened)	1-1/8"-16	3/4"-16	2-9/16"	Long Inner Nut. Used when steel wheel is used on the inside dual and aluminum wheel on the outside dual.
E7897-R & L (Hardened)	1-1/8"-16	3/4"-16	3-1/16"	Extra Long Steel Inner Nut (Steel Inner Wheel & Aluminum Outer Wheel)

Steel Wheel Outer and Front Nuts

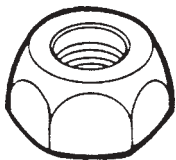
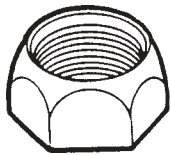

Part No.	Thread	Hex	High	Application
E5977-R & L (Hardened)	1-1/8"-16	1-1/2"	7/8"	1-1/8" Outer & Front Nut for Steel & Aluminum Wheels
E5652-R & L	3/4"-16	1-1/2"	7/8"	3/4" Front Nut for Steel Wheels

Budd-Type Chrome Hug-A-Lug Nut Covers



For Stud-Piloted Budd-Type Double Cap Nut Wheel. 1-1/2" Hex.

Description	Part No.	Fits
Chrome Hug-A-Lug	000150	1-1/2" Hex



Heavy Duty Nuts Aluminum Inner Wheel Nuts

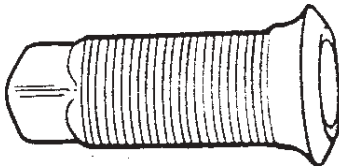
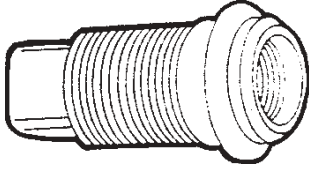

Part No.	Thread O.D.	Thread I.D.	O.A. Length	Application
E5988-R & L (Hardened)	1-1/8"-16	3/4"-16	3-1/16"	Aluminum wheel inner nut.
E7896-R & L (Hardened)	1-1/8"-16	3/4"-16	2-9/16"	Inner Wheel Nut for steel inner wheel and aluminum outer wheel.
E7897-R & L	1-1/8"-16	3/4"-16	3-1/16"	Extra Long Inner Nut (Steel Inner Wheel & Aluminum Outer Wheel)

Heavy Duty Nuts Aluminum Outer and Single Wheel Nuts

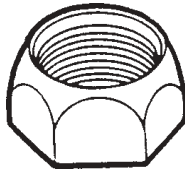

Part No.	Thread	Hex	High	Application
E5977-R & L (Hardened)	1-1/8"-16	1-1/2"	7/8"	1-1/8" Aluminum Wheel Outer & Front Nut
E5995-R & L	3/4"-16	1-1/2"	1-3/8"	3/4" Single Nut for rear and trailer using Alcoa wide base wheels.
E5996-R & L	1-1/8"-16	1-1/2"	1"	"Long Grip" Nut. Used on front 1-1/8" studs using Alcoa wide base wheels.

Budd-Type Chrome Hug-A-Lug Nut Covers



For Stud-Piloted Budd-Type Double Cap Nut Wheel. 1-1/2" Hex.

Description	Part No.	Fits
Chrome Hug-A-Lug	000150	1-1/2" Hex



**Heavy Duty Nuts
Hub Piloted Single Nuts
Steel Wheels**



Part No.	Thread	Hex	High	Application
E6000A	M22 x 1.5	33mm	32mm	Two-Piece Washered Nut for Budd Uni-Mount-10 (10 Stud) Type Hub Piloted Wheel System

Budd Uni-Mount-10 Type Chrome Hug-A-Lug Nut Covers



Description	Part No.	Fits
33mm Hex for Budd Uni-Mount-10 Type Nut	000181	33mm Hex

**Heavy Duty Nuts
Hub Piloted Single Nuts
Steel Wheels**



Part No.	Thread	Hex	High	Application
E5991	M22 x 1.5	1-1/2"	1-1/2"	Two-Piece Washered Nut for Motor Wheel WHD-8 (8 Stud) Type Hub Piloted Wheel System

Motor Wheel WHD-8 Type Chrome Hug-A-Lug Nut Covers



Description	Part No.	Fits
1-1/2" Hex for Motor Wheel WHD-8 Type Nut	000182	1-1/2" Hex



Wheel Guards

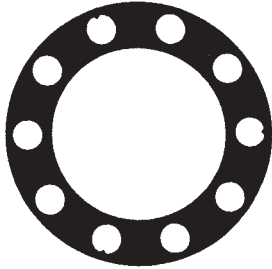

The Wheel-Guard is a nylon separator plate, approximately .040" thick. It is placed between the hub or drum and the wheel, and/or between two wheels in a dual application. The Wheel-Guard is recommended in severe applications where corrosion and/or wear has been identified as a problem. Both aluminum and steel wheels can benefit from the use of the Wheel-Guard. Care must be exercised in centering the wheel-guard prior to torquing and stud length must be checked to provide adequate nut engagement as each plate is approximately .040" thick.

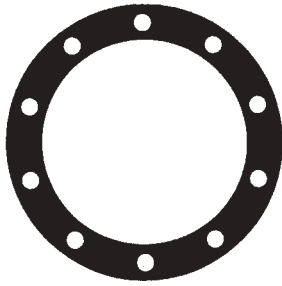

Application	Use Part No.
10 Hole, 11-1/4" bolt circle, stud piloted; 3/4" diameter studs	F5902
10 Hole, 11-1/4" bolt circle, stud piloted; 7/8" and 1-1/8" diameter studs	F5901
10 Hole, 285.75mm bolt circle, hub piloted; 22mm diameter studs	F5903



TUBELESS DEMOUNTABLE RIMS

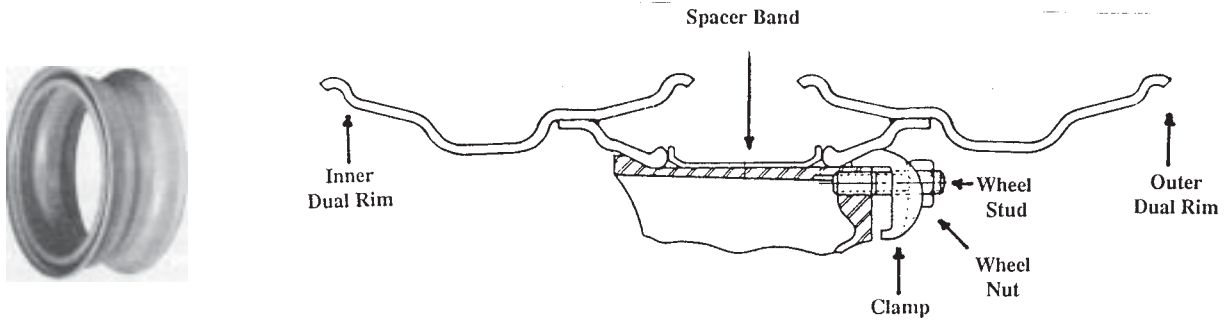

Capacity Size	Application	Part No.	Capacity Lbs.
17.5" X 6.75"	Tire 9R	F31868175	4805
22.5" X 8.25"	Tire 11.00	F30391225	7300
24.5" X 8.25	Tire 11.00	F30391245	7300



TUBE TYPE DEMOUNTABLE RIMS

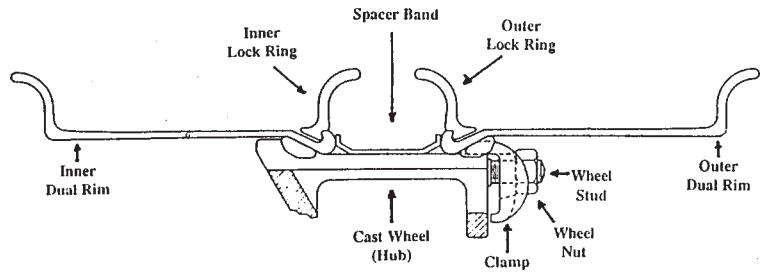

Rim Size	Application	Rim & Ring(s) Kit Number	Kit Contents	Capacity Lbs
15" x 6.5" (Special Order)	Tire 8.25	6515LWD	B6515LWD Base R6515LW Ring	4290
15" X 7.5" (Special Order)	Tire 10.00	7515LWD	B7515LWD Base R8015LW Ring	5520
20" X 6.5" (Special Order)	Tire 8.25	6520LWD	B6520LWD Base R6520LW Ring	4610
20" X 7.5" (Special Order)	Tire 10.00	7520LWD	B7520LWD Base R8020LW Ring	6400
20" X 8" (Special Order)	Tire 11.00	8020LWD	B8020LWD Base R8020LW Ring	7600
20" X 9.0" (Special Order)	Tire 12.00	9020LWD	B9020LWD Base R8020LW Ring	9230
20" X 10.0"	Three Piece MD Style Tire 14.00 (Special Order)	1020MD	B1020MD Base F1020M Flange LR20M Ring	9610
24" X 8"	Tire 11.00 (Special Order)	8024LWD	B8024LWD R8024LW	7600
24" X 9"	Tire 12.00 (Special Order)	9024LWD	B9024LWD Base R8024LW Ring	9230
24" X 10"	Tire 14.00 (Special Order)	1024MD	B1024MD Base F1024M Flange LR24M Ring	9740



DEMOUNTABLE RIM ATTACHING PARTS

Euclid Wall Charts Available

Coarse Demountable Rim Nuts



Part No.	Thread	Hex	Description
E4962 (Special Order)	5/8"-11	1-1/16"	5/8" Coarse Nut
E4963	3/4"-10	1-1/4"	3/4" Coarse Nut

Coarse Studs for Spoke Wheels, Grade 8



Part No.	Thread	A	B	C
E4956A	3/4"-10	3"	1-1/16"	1-3/4"



DEMOUNTABLE RIM SPACER BANDS

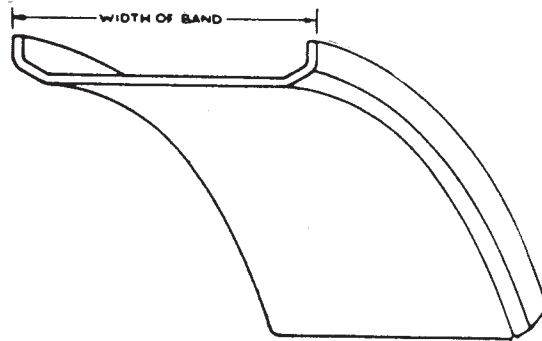

Part No.	Size	Other Information
SB4015K (Special Order)	15 x 4	Also for 17.5" Rims
SB3320K (Special Order)	20 x 3-3/8	Also for 22.5" Rims
SB3520K (Special Order)	20 x 3-5/8	Also for 22.5" Rims
SB4020K (Special Order)	20 x 4	Also for 22.5" Rims
SB4220K	20 x 4-1/4	Also for 22.5" Rims
SB4420K (Special Order)	20 x 4-1/2	Also for 22.5" Rims
SB4022K	22 x 4	Also for 24.5" Rims
SB4222K	22 x 4-1/4	Also for 24.5" Rims



LOCK RINGS

Motor Wheel (Goodyear) and Budd LW Rings

LW 2-Piece Tube-Type Wheel (Rim)

Single Lock Ring

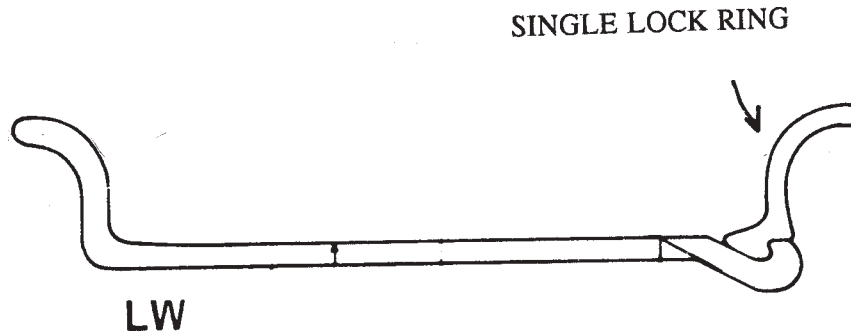

****Match the marking in the wheel or rim with the marking on the ring.****

Wheel (Rim) Marking	Ring Part Number	Ring Marking
15 x 6.5 LW (Special Order)	R6515LW	R15 x 6.5-7.0 LB-LW
15 x 7.5 LW (Special Order)	R8015LW	R15 x 7.5-8.0-9.0 LB-LW
20 x 6.5 LW (Special Order)	R6520LW	R20 x 6.5-7.0 LB-LW
20 x 7.5 LW	R8020LW	R20 x 7.5-8.0-9.0 LB-LW
20 x 8.0 LW	R8020LW	R20 x 7.5-8.0-9.0 LB-LW
20 x 9.0 LW	R8020LW	R20 x 7.5-8.0-9.0 LB-LW
24 x 8.0 LW (Special Order)	R8024LW	R24 x 7.5-8.0-9.0 LB-LW



LOCK RINGS, CONT.

Motor Wheel (Goodyear) and Budd M-Rings

3-Piece Wheel (Rim)

Double Lock Ring

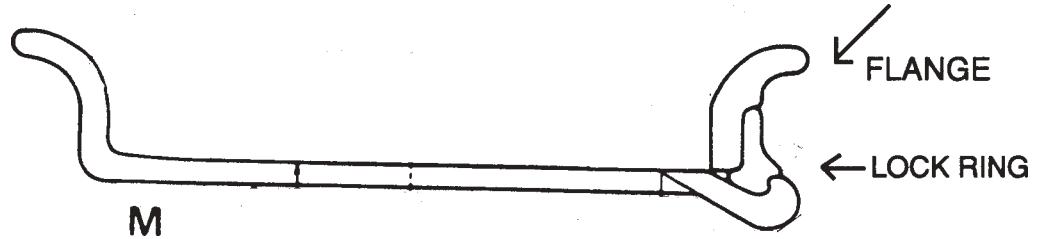

****Match the marking in the wheel or rim with the marking on the ring.****

Wheel (Rim) Marking No.	Flange Part No.	Flange Marking	Lock Ring Part No.	Lock Ring Marking
20 x 7.5 M	F7520M	F20 x 7.5-8.5M	LR20M	LR20 x 7.5-8.5-10.0M
20 x 8.5 M	F7520M	F20 x 7.5-8.5M	LR20M	LR20 x 7.5-8.5-10.0M
20 x 10 M	F1020M	F20 x 10M	LR20M	LR20 x 7.5-8.5-10.0M
24 x 7.5M	F7524M	F24 x 7.5-8.5M	LR24M	LR24 x 7.5-8.5-10.0M
24 x 8.5M	F7524M	F24 x 7.5-8.5M	LR24M	LR24 x 7.5-8.5-10.0M
24 x 10 M	F1024M	F24 x 10M	LR24M	LR24 x 7.5-8.5-10.0M



LOCK RINGS, CONT.

**Accuride (Firestone) 5 Degree
3-Piece Wheel (Rim) Tube-Type
Double Lock Ring**

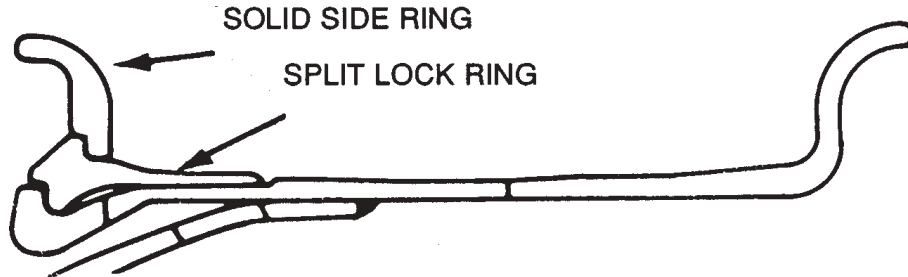

****Match the marking in the wheel or rim with the marking on the ring.****

Wheel (Rim) Marking	Split Lock Ring Part Number	Split Lock Ring Marking	Solid Side Ring Part Number	Solid Side Ring Marking
20 x 7.5 5°	F240D5LR	20 x 7.0-7.5-8.0 5°	F262D5SR	20 x 7.5-8.0 5°
20 x 8.0 5°	F240D5LR	20 x 7.0-7.5-8.0 5°	F262D5SR	20 x 7.5-8.0 5°



WARNING

**Wheel and tire servicing can be dangerous.
To protect life and limb, be sure you understand
and follow all mounting, demounting, maintenance,
inspection, operational procedures and safety
instructions and practices.**

For complete information contact:

**Henderson Wheel & Warehouse Supply
1825 South 300 West
Salt Lake City, UT 84115**

or

**Henderson Wheel & Supply
112 West 34th Street
Boise, ID 83714**

**Come see us at
one of our six
Henderson
Locations:**

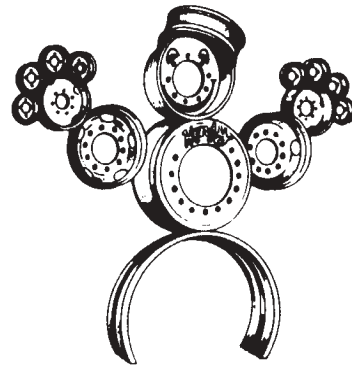

Henderson Wheel and Warehouse Supply

1825 South 300 West • Salt Lake City, UT 84115

Tel: (801)486-2073 • Toll Free: (800)748-5111 • Fax: (801)486-0353

Henderson Parts Pros

3144 Grant Avenue • Ogden, UT 84401

Tel: (801)393-0440 • Toll Free: (800)627-3956 • Fax: (801)621-0781

Henderson Parts Pros

7480 South State Street • Midvale, UT 84047

Tel: (801)566-6566 • Fax: (801)352-2535

Henderson Parts Pros

333 North State Street • Orem, UT 84057

Tel: (801)229-2333 • Toll Free: (888)586-8774 • Fax: (801)224-8612

Henderson Parts Pros

4151 West 5415 South • Kearns, UT 84118

Tel: (801)965-1611 • Fax: (801)965-1616

Henderson Wheel & Supply

112 W. 34th Street • Boise, ID 83714

Tel: (208)344-6525 • Toll Free: (800)248-3444 • Fax: (208)336-1296