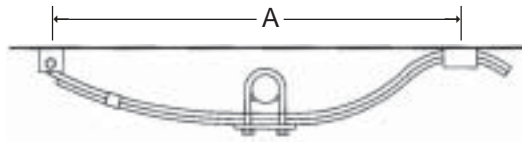
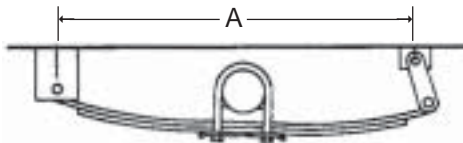

SINGLE AXLE HANGER KIT WITH 1.75" SLIPPER SPRING

Kit #	Qty.	Part #	Description	Hanger Placement		
				Spring #	Spring Length	A
SHK175SS			Complete Hanger Kit			
	2	H-2L	Front Hanger	BT25-9	25"	23.5"
	2	E-6	Rear Hanger	BT25-12	25"	23.5"
	2	B-3	Shackle Bolt			
	2	B-2	Lock Nut			

SINGLE AXLE HANGER KIT WITH 1.75" DOUBLE EYE SPRING

Kit #	Qty.	Part #	Description	Hanger Placement		
				Spring #	Spring Length	A
*SHK251			Complete Hanger Kit			
	2	H-2L	Front Hanger	72-17	20.38"	19"
	2	E-3	Rear Hanger	SW- Series	25.25"	24.25"
	4	L-1	Shackle Strap	AWS- Series	26"	25"
	6	B-3	Shackle Bolt	72-26	25.25"	24.25"
	6	N-2	Lock Nut			
*SHK30			Complete Hanger Kit			
	2	H-33	Front Hanger	72-17	20.38"	19"
	2	E-3	Rear Hanger	SW- Series	25.25"	24.25"
	4	L-1	Shackle Strap	AWS- Series	26"	25"
	6	B-3	Shackle Bolt	72-26	25.25"	24.25"
	6	N-2	Lock Nut			

* Boxed Hanger Kits Available



SINGLE AXLE HANGER KIT WITH 1.75" DOUBLE EYE SPRING

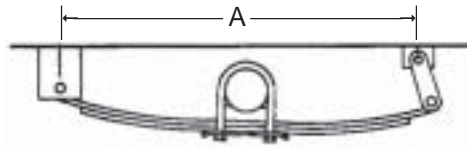

Kit #	Qty.	Part #	Description	Hanger Placement		
				Spring #	Spring Length	A
*SHK252			Complete Hanger Kit			
	2	H-2L	Front Hanger	72-17	20.38"	19"
	2	E-3	Rear Hanger	SW- Series	25.25"	24.25"
	4	L-6	Shackle Strap	AWS- Series	26"	25"
	6	B-3	Shackle Bolt	72-26	25.25"	24.25"
	6	N-2	Lock Nut			

* Boxed Hanger Kits Available

SINGLE AXLE HANGER KIT WITH 2.00" SLIPPER SPRING

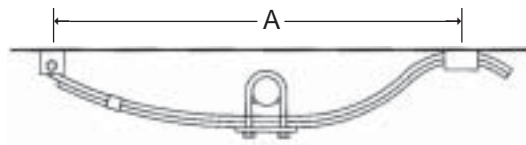

Kit #	Qty.	Part #	Description	Hanger Placement		
				Spring #	Spring Length	A
SHK36			Complete Hanger Kit			
	2	72-1584-3	Front Hanger	E5224-1	26.5"	25"
	2	72-1585-3-G	Rear Hanger	E5226	26.5"	25"
	4	B91635	Shackle Bolt	E5226-1	26.5"	25"
	4	N-2	Lock Nut	E5116	26.5"	25"
				E5115	29"	28"

TANDEM AXLE HANGER KIT WITH 1.75" DOUBLE EYE SPRING

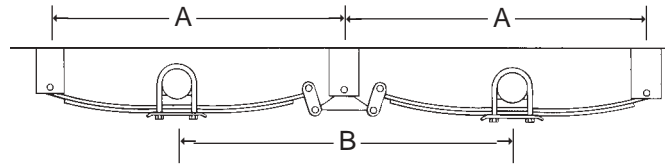

Kit #	Qty.	Part #	Description	Hanger Placement			
				Spring #	Spring Length	A	B
THK251			Complete Hanger Kit				
	4	H-2L	Front & Rear Hanger	72-17	20.38"	25"	28.75"
	2	RH-1	Center Hanger	SW- Series	25.25"	29.25"	33.25"
	2	R-3	Equalizer	AWS- Series	26"	30"	34"
	8	L-1	Shackle Strap	72-26	25.25"	29.25"	33.25"
	14	B-3	Shackle Bolt				
	14	N-2	Lock Nut				
THK2581			Complete Hanger Kit				
	4	H-2L	Front & Rear Hanger	72-17	20.38"	25"	28.75"
	2	H-33	Center Hanger	SW- Series	25.25"	29.25"	33.25"
	2	R-8B	Equalizer	AWS- Series	26"	30"	34"
	8	L-1	Shackle Strap	72-26	25.25"	29.25"	33.25"
	14	B-3	Shackle Bolt				
	14	N-2	Lock Nut				
THK30			Complete Hanger Kit				
	4	H-33	Front & Rear Hanger	72-17	20.38"	25"	28.75"
	2	RH-1	Center Hanger	SW- Series	25.25"	29.25"	33.25"
	2	R-3	Equalizer	AWS- Series	26"	30"	34"
	8	L-1	Shackle Strap	72-26	25.25"	29.25"	33.25"
	14	B-3	Shackle Bolt				
	14	N-2	Lock Nut				
THK308			Complete Hanger Kit				
	6	H-33	Front, Center & Rear Hanger	72-17	20.38"	25"	28.75"
	2	R-8B	Equalizer	SW- Series	25.25"	29.25"	33.25"
	8	L-3	H.D.Shackle Strap	AWS- Series	26"	30"	34"
	14	B-3	Shackle Bolt	72-26	25.25"	29.25"	33.25"
	14	N-2	Lock Nut				
THK3081			Complete Hanger Kit				
	6	H-33	Front, Center & Rear Hanger	72-17	20.38"	25"	28.75"
	2	R-8B	Equalizer	SW- Series	25.25"	29.25"	33.25"
	8	L-1	Shackle Strap	AWS- Series	26"	30"	34"
	14	B-3	Shackle Bolt	72-26	25.25"	29.25"	33.25"
	14	N-2	Lock Nut				

* Boxed Hanger Kits Available



TANDEM AXLE HANGER KIT WITH 1.75" DOUBLE EYE SPRING

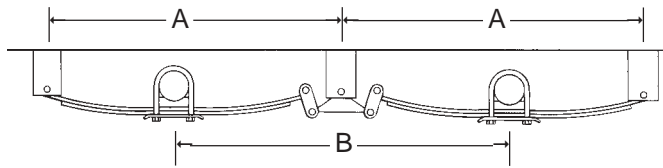

Kit #	Qty.	Part #	Description	Hanger Placement			
				Spring #	Spring Length	A	B
THK30B			Complete Hanger Kit				
	6	H-33	Front, Center & Rear Hanger	SW- Series	25.25"	29.5"	33.5"
	2	A2252CB	Equalizer	AWS- Series	26"	33.25"	34.5"
	8	L-6	Shackle Strap	72-26	25.25"	29.5"	33.5"
	14	B-3	Shackle Bolt				
	14	N-2	Lock Nut				

TANDEM AXLE HANGER KIT WITH 2.00" SLIPPER SPRING

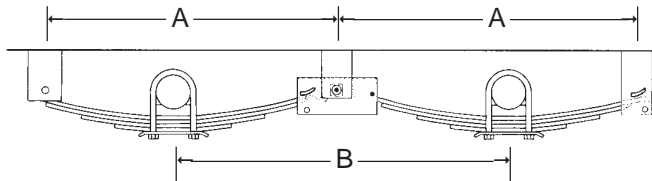

Kit #	Qty.	Part #	Description	Hanger Placement			
				Spring #	Spring Length	A	B
THK36			Complete Hanger Kit				
	2	72-1584-3	Front Hanger	E5224-1	26.5"	29.5	34.5"
	2	72-1586-3	Center Hanger	E5226	26.5"	29.5	34.5"
	2	72-1585-3-G	Rear Hanger	E5226-1	26.5"	29.5	34.5"
	2	72-1587	Equalizer	E5116	26.5"	29.5	34.5"
	8	B91635	Shackle Bolt	E5115	29.00"	32.00"	36.75"
	8	N-2	9/16" Lock Nut				
	2	7-1	Equalizer Bolt				
	2	N78	7/8" Lock Nut				

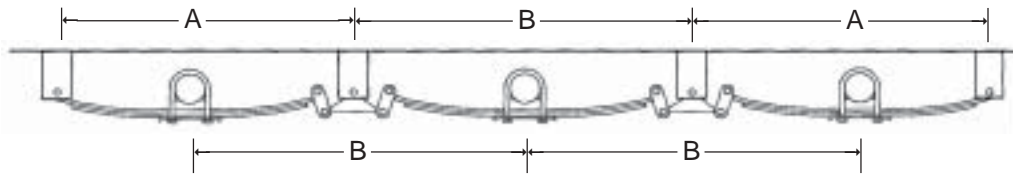
TRIPLE AXLE HANGER KIT WITH 1.75" DOUBLE EYE SPRING

Kit #	Qty.	Part #	Description	Hanger Placement			
				Spring #	Spring Length	A	B
TTHK251			Complete Hanger Kit				
	4	H-2L	Front & Rear Hanger	72-17	20.38"	25"	28.75"
	4	RH-1	Center Hanger	SW- Series	25.25"	29.25"	33.25"
	4	R-3	Equalizer	AWS- Series	26"	30"	34"
	16	L-1	Shackle Strap	72-26	25.25"	29.25"	33.25"
	24	B-3	Shackle Bolt				
	24	N-2	Lock Nut				
TTHK2581			Complete Hanger Kit				
	4	H-2L	Front & Rear Hanger	72-17	20.38"	25"	28.75"
	4	H-33	Center Hanger	SW- Series	25.25"	29.25"	33.25"
	4	R-8B	Equalizer	AWS- Series	26"	30"	34"
	16	L-1	Shackle Strap	72-26	25.25"	29.25"	33.25"
	24	B-3	Shackle Bolt				
	24	N-2	Lock Nut				
TTHK30			Complete Hanger Kit				
	4	H-33	Front & Rear Hanger	72-17	20.38"	25"	28.75"
	4	RH-1	Center Hanger	SW- Series	25.25"	29.25"	33.25"
	4	R-3	Equalizer	AWS- Series	26"	30"	34"
	16	L-1	Shackle Strap	72-26	25.25"	29.25"	33.25"
	24	B-3	Shackle Bolt				
	24	N-2	Lock Nut				
TTHK308			Complete Hanger Kit				
	8	H-33	Front, Center & Rear Hanger	72-17	20.38"	25"	28.75"
	4	R-8B	Equalizer	SW- Series	25.25"	29.25"	33.25"
	16	L-3	H.D.Shackle Strap	AWS- Series	26"	30"	34"
	24	B-3	Shackle Bolt	72-26	25.25"	29.25"	33.25"
	24	N-2	Lock Nut				
TTHK3081			Complete Hanger Kit				
	8	H-33	Front, Center & Rear Hanger	72-17	20.38"	25"	28.75"
	4	R-8B	Equalizer	SW- Series	25.25"	29.25"	33.25"
	16	L-1	Shackle Strap	AWS- Series	26"	30"	34"
	24	B-3	Shackle Bolt	72-26	25.25"	29.25"	33.25"
	24	N-2	Lock Nut				



TRIPLE AXLE HANGER KIT WITH 2.00" SLIPPER SPRING

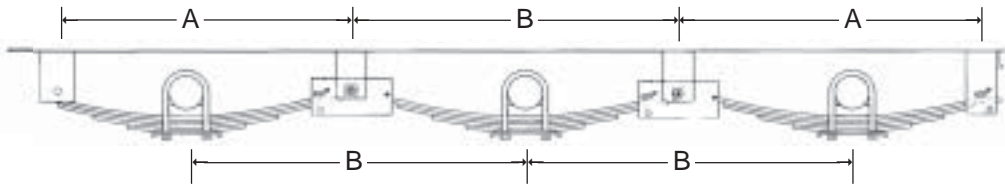

Kit #	Qty.	Part #	Description	Hanger Placement			
				Spring #	Spring Length	A	B
TTHK36			Complete Hanger Kit				
	2	72-1584-3	Front Hanger	E5224-1	26.5"	29.5	34.5"
	4	72-1586-3	Center Hanger	E5226	26.5"	29.5	34.5"
	2	72-1585-3-G	Rear Hanger	E5226-1	26.5"	29.5	34.5"
	4	72-1587	Equalizer	E5116	26.5"	29.5	34.5"
	12	B91635	Shackle Bolt	E5115	29.00"	32.00"	36.75"
	12	N-2	9/16" Lock Nut				
	4	7-1	Equalizer Bolt				
	4	N78	7/8" Lock Nut				

8000 LB. TANDEM AXLE HANGER KIT WITH 2.00" SLIPPER SPRING

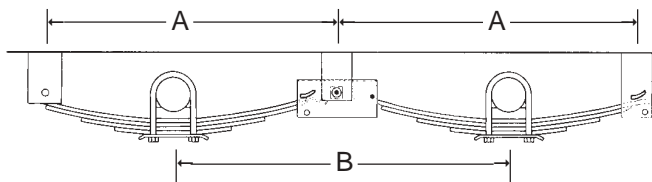

Kit #	Qty.	Part #	Description	Hanger Placement			
				Spring #	Spring Length	A	B
90190606			Complete Hanger Kit	E5115	29.00"	33.25"	39.00"

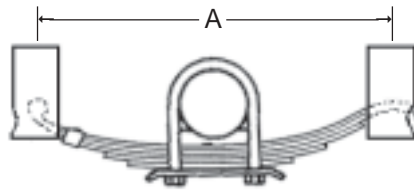
HEAVY DUTY SINGLE AXLE HANGER KIT WITH 2.50" SLIPPER SPRINGS

Kit #	Qty.	Part #	Description	Hanger Placement		
				Spring #	Spring Length	A
9941	Complete Hanger Kit			8130	35.50"	29.25"
	2	7417	Front Hanger			
	2	7418	Rear Hanger			
	4	5821	Shackle Bolt			
	4	6715	Lock Nut			

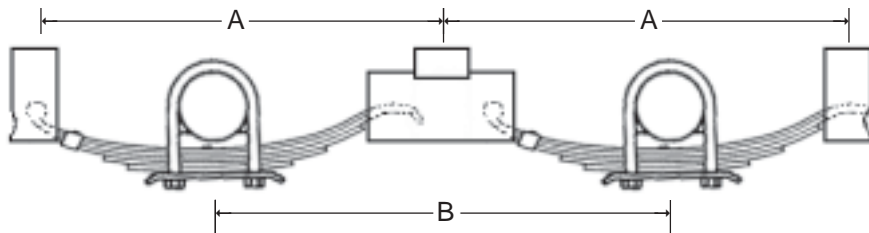
HEAVY DUTY TANDEM AXLE HANGER KIT WITH 2.50" SLIPPER SPRINGS

Kit #	Qty.	Part #	Description	Hanger Placement			
				Spring #	Spring Length	A	B
9937	Complete Hanger Kit			8131	35.5"	35.5"	42.35"
	2	7417	Front Hanger				
	2	7418	Rear Hanger				
	2	7416	Center Hanger				
	1	8320	RH Equalizer				
	1	8319	LH Equalizer				
	2	6716	Equalizer Lock Nut				
	4	6715	Lock Nut				
	2	5819	Equalizer Bolt				
	4	5821	Shackle Bolt				



HEAVY DUTY TRIPLE AXLE HANGER KIT WITH 2.50" SLIPPER SPRINGS

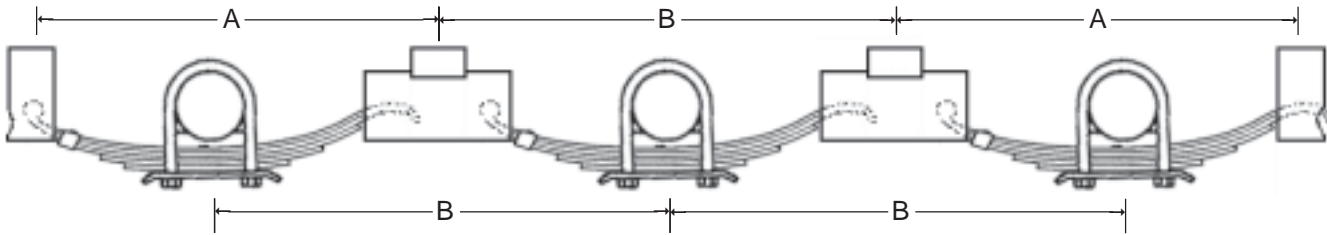

Kit #	Qty.	Part #	Description	Hanger Placement			
				Spring #	Spring Length	A	B
9939			Complete Hanger Kit				
	2	7417	Front Hanger	8132	35.5"	35.5"	42.25"
	2	7418	Rear Hanger				
	4	7416	Center Hanger				
	2	8320	RH Equalizer				
	2	8319	LH Equalizer				
	4	6716	Equalizer Lock Nut				
	6	6715	Lock Nut				
	4	5819	Equalizer Bolt				
	6	5821	Shackle Bolt				

TRAILER SPRINGS

TYPE 1
Slipper Spring - Flat End Length

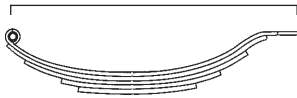

TYPE 2
Double Eye Length

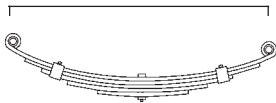

TYPE 3
Slipper Spring - Hook End Length

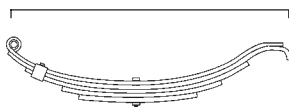

Part No.	Leaves	Max.*** Cap. (ea)	Leaf Thickness	Length	Width	Free Height	Type
BT25-9	3	900	.262	25.00	1.75	3.50	1
AWS-2	2	1000	.360	26.00	1.75	4.25	2
72-17	3	1000	.262	20.38	1.75	3.18	2
SW-3B	3	1000	.3125	25.25	1.75	3.00	2
BT25-12	4	1200	.262	25.00	1.75	3.50	1
72-6	3	1250	2).323 1).291	23.125	1.75	3.625	2
AWS-3	3	1500	.360	26.00	1.75	4.25	2
SW-4B	4	1750	.3125	25.25	1.75	3.00	2
E5224-1*(72-30)	4	2000	1).360 3).323	26.88	2.00	3.00	3
AWS-4	4	2000	.360	26.00	1.75	4.25	2
AWS-5	5	2500	.360	26.00	1.75	4.25	2
HW-1	1	3000	.950	25.25	1.75	3.13	2
72-26	4	3000	Tapered 3) .401 1) .360	25.13	1.75	3.12	2
E5226	5	3000	.360	26.50	2.00	3.50	3
AWS-6	6	3000	.360	26.00	1.75	4.25	2
E5226-1*(72-32)	5	3500	.360	26.88	2.00	3.19	3
AWS-7	7	3500	.360	26.00	1.75	4.25	2
E5116	6	3600	.360	27.00	2.00	3.50	3
E5115	6	4000	.401	30.50**	2.00	3.50	3
8130	4	4500	.447	32.50	2.50	4.00	3
8131	5	5000	.447	32.50	2.50	4.00	3
8132	6	6000	.447	32.50	2.50	4.00	3

* 7/8" Offset Pin Towards Front

** Some have a length of 29"

*** If springs are used commercially, off road, or under abusive situations, heavier springs and running gear are recommended.

NYLON BUSHINGS

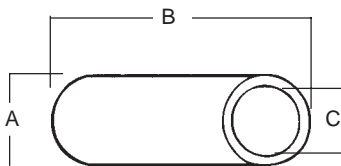

Part No.	Outside Diameter A	Inside Diameter B	Length C	Application
NB-17	11/16"	9/16"	1-3/4"	Spring Eye
NB-10	3/4"	9/16"	1-3/4"	Spring Eye
NB-20	11/16"	9/16"	2.00"	Spring Eye
14-54-01	1.131"	.57"	2.20"	Spring Eye



ROUND AXLE U-BOLT KITS
(Spring Not Included)

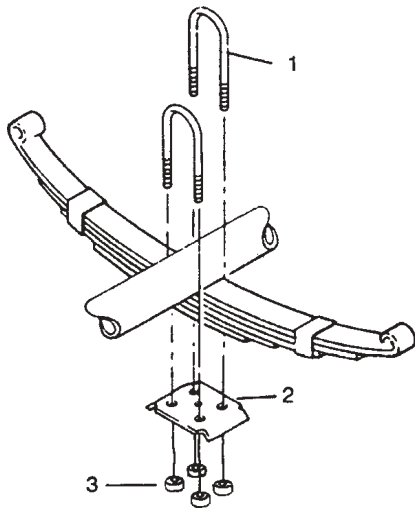

U-Bolt Kit for 2000 lb. 1-3/4" Round Axles w/1-3/4" Wide Springs

Kit No.	Qty.	Part No.	Description
UBK1741			Complete U-Bolt Kit
	(1) 4	U-1741	U-Bolt
	(2) 2	91207	Tie Plate
	(3) 8	UN-4	U-Bolt Nut

U-Bolt Kit for 3500 lb. 2-3/8" Round Axles w/1-3/4" Wide Springs

Kit No.	Qty.	Part No.	Description
UBK255			Complete U-Bolt Kit
	(1) 4	U-1105	U-Bolt
	(2) 2	2101	Tie Plate
	(3) 8	UN-2	U-Bolt Nut

U-Bolt Kit for 3500 lb. 2-3/8" Round Axles with 2" Wide Springs

Kit No.	Qty.	Part No.	Description
UBK255-2			Complete U-Bolt Kit
	(1) 4	U-1105	U-Bolt
	(2) 2	2102	Tie Plate
	(3) 8	UN-2	U-Bolt Nut

U-Bolt Kit for 5200 lb., 6000 lb. and 7000 lb. 3" Round Axles with 1-3/4" Wide Springs

Kit No.	Qty.	Part No.	Description
UBK306			Complete U-Bolt Kit
	(1) 4	U-136	U-Bolt 3" x 6"
	(2) 2	12-1	Tie Plate
	(3) 8	UN-2	U-Bolt Nut

U-Bolt Kit for 5200 lb., 6000 lb. and 7000 lb. 3" Round Axles with 2" Wide Springs

Kit No.	Qty.	Part No.	Description
UBK306-2			Complete U-Bolt Kit
	(1) 4	U-136	U-Bolt 3" x 6"
	(2) 2	12-2H	Tie Plate
	(3) 8	UN-2	U-Bolt Nut

U-Bolt Kit for 5200 lb., 6000 lb. and 7000 lb. 3" Round Axles with 1-3/4" Wide Springs

Kit No.	Qty.	Part No.	Description
UBK307			Complete U-Bolt Kit
	(1) 4	U-137	U-Bolt 3" x 7"
	(2) 2	12-1	Tie Plate
	(3) 8	UN-2	U-Bolt Nut

U-Bolt Kit for 5200 lb., 6000 lb. and 7000 lb. 3" Round Axles with 2" Wide Springs

Kit No.	Qty.	Part No.	Description
UBK307-2			Complete U-Bolt Kit
	(1) 4	U-137	U-Bolt 3" x 7"
	(2) 2	12-2H	Tie Plate
	(3) 8	UN-2	U-Bolt Nut



U-BOLT SPECIFICATIONS

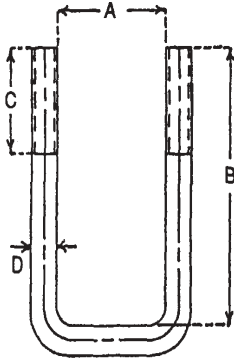
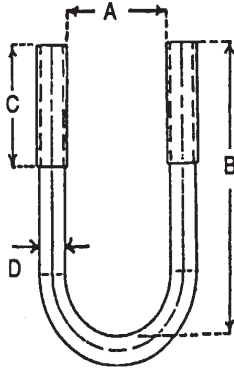

Part No.	Square or Round	Axle Size		Thread Length C	Mat. Diam. - Thread D	U-Bolt Nut
		A	B			
U-1741	R	1-3/4"	4-1/32"	1-1/4"	3/8" - 24	UN-4
DOR660-102*	R	2-1/4"	6"	3"	7/16" - 20	*
U-1105	R	2-3/8"	5-1/2"	2"	1/2" - 20	UN-2
U-1106	R	2-3/8"	6-1/4"	1-7/8"	1/2" - 20	UN-2
DOR660-103*	R	2-1/2"	6-1/2"	3"	7/16" - 20	*
DOR660-109*	R	2-7/8"	7"	3"	1/2" - 20	*
U-135	R	3"	5-3/8"	1-7/8"	1/2" - 20	UN-2
U-136	R	3"	6-3/8"	1-7/8"	1/2" - 20	UN-2
U-137	R	3"	7"	2"	1/2" - 20	UN-2
DOR660-105*	R	3-1/16"	6-3/4"	3"	7/16" - 20	*
DOR660-110*	R	3-1/8"	9"	3"	1/2" - 20	*
5911	R	3-1/2"	9"	3"	5/8" - 11	-
5912	R	5"	9-1/2"	2-1/2"	5/8" - 11	910-016
5913	R	5"	10-1/2"	2-1/2"	5/8" - 11	910-016
U-40	S	1-1/2"	4-1/4"	2"	1/2" - 20	UN-2
DOR660-106*	S	1-3/4"	4-1/4"	2"	1/2" - 20	*
U-945	S	1-3/4"	4-1/2"	1-7/8"	9/16" - 18	UN-1
U-8	S	2"	5-1/2"	2-1/2"	9/16" - 18	UN-1
U-27	S	2"	6-3/4"	2-1/2"	9/16" - 18	UN-1
DOR660-107*	S	2-1/16"	3-3/4"	2"	1/2" - 20	*
DOR660-113*	S	2-1/16"	5-1/2"	2"	9/16" - 18	*
DOR660-108*	S	2-1/16"	8-1/2"	3"	1/2" - 20	*
DOR660-111*	R	3-1/8"	6-1/2"	3"	1/2" - 20	*
DOR660-112*	R	3-1/8"	8"	3-1/2"	1/2" - 20	UN-2
DOR660-115*	R	3-1.8"	6-1/2"	3"	7/16" - 20	*
DOR660-116*	R	3-1/8"	7-1/2"	3"	1/2" - 20	*
DOR660-118	S	2"	6"	3"	1/2" - 20	*
DOR660-119*	R	3-1/2"	7-1/2"	3"	1/2" - 20	*
DOR660-120*	R	3-1/4"	9"	3"	1/2" - 20	*
DOR660-121*	R	3-3/8"	7"	3"	9/16" - 18	*
DOR660-122*	R	3"	7-1/2"	3"	5/8" - 18	*

*Sold two per box, U-Bolt nuts included.

TIE PLATE SPECIFICATIONS

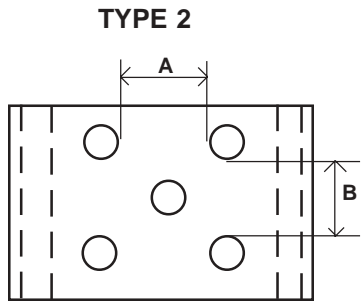
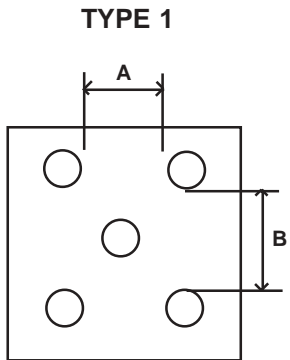

Part No.	Axle Diameter A	Spring Width B	U-Bolt Diameter	Use With U-Bolt	Type
91207	1-3/4"	1-3/4"	3/8"	U-1741	1
2101	2-3/8"	1-3/4"	1/2"	U-1105	2
2102	2-3/8"	2"	1/2"	U-1106	2
12-1	3"	1-3/4"	1/2"	U-1105	2
				U-1106	
12-2H	3"	2"	1/2"	U-135	2
				U-136	
				U-137	
7711	3.5"	2"	5/8"	U-135	2
7708	5"	2.5"	5/8"	U-136	2
				U-137	
				U-395	2
				5912	2
				5913	

AXLE SADDLES

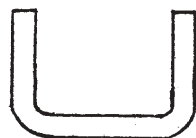
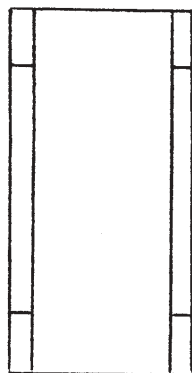
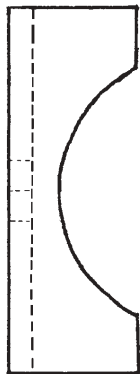

Part No.	Application
3-23	1-3/4" Round Axle
3-8	2-3/8 To 2 1/2" Round Axle
3-1	3" Round Axle
7604	3-1/2" Round Axle
7616	5" Round Axle

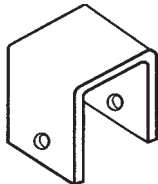
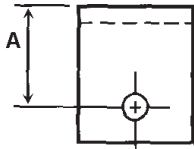
HANGERS FOR 1-3/4" WIDE DOUBLE EYE SPRINGS

Part No.	Description	"A"	Bolt Size
H-2L	Front & Rear Hanger	1-7/8"	9/16"
H-33	Front & Center Rear Hanger	3-1/4"	9/16"
RH-1	Center Hanger	4-3/4"	9/16"
E-3	Rear Hanger	1-1/8"	9/16"

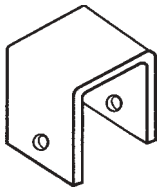
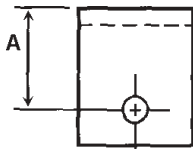
HANGERS FOR 2" WIDE SLIPPER SPRINGS

Part No.	Description	"A"	Bolt Size
E-6	C-Clip Rear Hanger for 2000 lb. Axle	-	-
72-1584-3	Front Hanger	3-13/16"	9/16"
72-1585-3-G	Rear Hanger w/Gusset	5-7/16"	9/16"
72-1586-3	Center Hanger	3-9/16"	7/8"

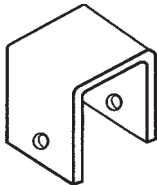
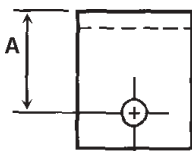
HEAVY DUTY HANGERS FOR 9K, 10K AND 12K AXLES

Part No.	Description	"A"	Bolt Size
7417	Front Hanger	5-1/2"	3/4"
7418	Rear Hanger	5-1/2"	3/4"
7416	Center Hanger	2"	1"

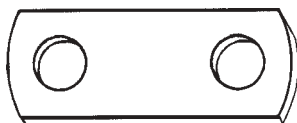
SHACKLE STRAPS

Part No.	Size	Bolt Size	Width
L-1	2-1/4" Center of Hole to Center of Hole	9/16"	1-1/4"
L-3	2-1/4" Center of Hole to Center of Hole	9/16"	1-1/2"
L-6	3-1/4" Center of Hole to Center of Hole	9/16"	1-1/4"

STRAIGHT EQUALIZERS FOR 1-3/4" WIDE SPRINGS

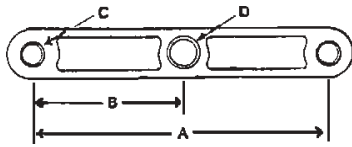

Part No.	A	B	C	D
R-3	5-1/2"	2-3/4"	9/16"	9/16"

TRIANGLE-TYPE EQUALIZERS FOR 1-3/4" WIDE SPRINGS

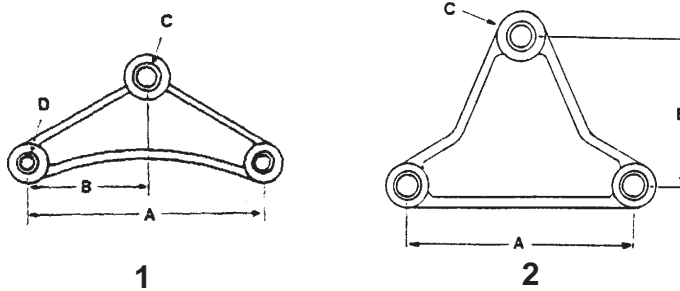

Part No.	Type	A	B	C	D
R-8B	1	5-11/16"	2-27/32"	9/16"	9/16"
A2252CB	1	7-3/4"	3-7/8"	9/16"	9/16"
13-10	2	6-1/16"	4"	9/16"	

2" SLIPPER SPRING EQUALIZERS

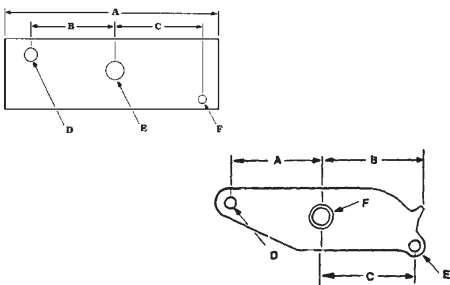

Part No.	A	B	C	D	E	F
72-1587	12"	4-3/4"	4-5/8"	9/16"	7/8"	9/16"
13-004	4-5/8"	5-1/2"	5	9/16"	5/16"	7/8"

2-1/2" SLIPPER SPRING EQUALIZERS

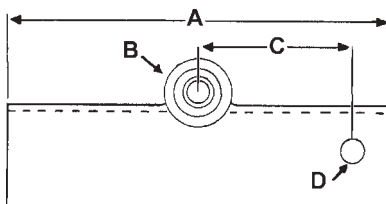

Part No.	A	B	C	D
8320 RH	15-3/4"	1"	7"	3/4"
8319 LH	15-3/4"	1"	7"	3/4"

SERRATED SHACKLE BOLTS

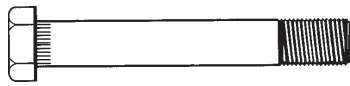

Part No.	Diameter	Thread	Length	Lock Nut	Type
	A	B	C		
B-3	9/16"	9/16"-18	3"	N-2	Dry Bolt
B91635	9/16"	9/16"-18	3-1/2"	N-2	Dry Bolt

HEAVY DUTY SHACKLE BOLT

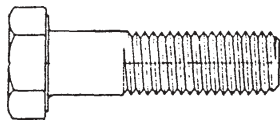

Part No.	Diameter	Thread	Length	Lock Nut	Type
	A	B	C		
5821	3/4"	3/4"-10	4-3/4"	6715	Dry Bolt

SERRATED SHACKLE BOLT WITH STEP DOWN TO THREAD



Part No.	Diameter	Thread	Length	Lock Nut	Type
	A	B	C		
B-4	9/16"	7/16"	3"	N-76	Dry Bolt

SERRATED SHACKLE BOLT WITH STEP DOWN TO THREAD (Lube Type)



Part No.	Diameter	Thread	Length	Lock Nut	Type
	A	B	C	C	
B-4L	9/16"	7/16"	3"	N-76	Wet Bolt
*B-5L	9/16"	7/16"	3.4"	N-76	Wet Bolt

*Existing Stock Only

CARRIAGE BOLT



Part No.	Diameter	Thread	Length	Lock Nut	Type
	A	B	C		
7-1	7/8"	7/8"-9	4.62"	N78	Lube Bolt w/Zerk

HEAVY DUTY EQUALIZER BOLT

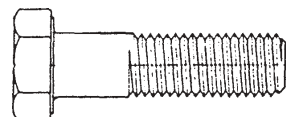

Part No.	Diameter	Thread	Length	Lock Nut	Type
	A	B	C		
5819	1"	1"-8	6.25"	6716	Dry Bolt



NUTS AND WASHERS

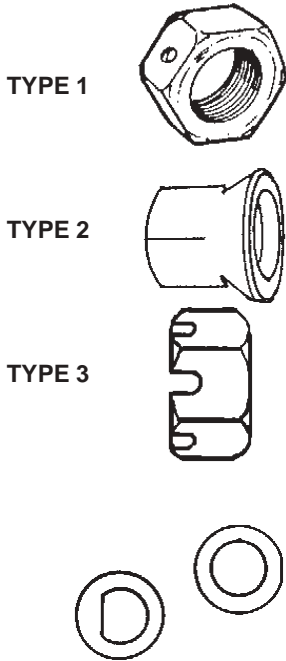

LOCK NUTS

Part No.	Thread	Type
N-76	7/16"-20	2
N-2	9/16"-18	1
N78	7/8"-9	1
6715	3/4"-10	1
6716	1"-8	1

HEX SLOTTED NUTS

(Use with Cotter Pin)

Part No.	Thread	Type
1-14	1"-14	3
K568135	1-1/2"-8	3

STANDARD HEX NUTS

Part No.	Thread	Type
UN-4	3/8"-24	1
UN-3	7/16"-20	1
UN-2	1/2"-20	1
UN-1	9/16"-18	1

WASHERS

Part No.	Description
LW716	7/16" Lock Washer
LW12	1/2" Lock Washer
LW916	9/16" Lock Washer
LW58	5/8" Lock Washer
1W	1" Spindle Washer
1DW	1" D-Washer
5-101	Tang Washer
K568136	1-1/2" Spindle Washer

AXLE NUT KIT

Part No.	Description	Size
K71-341-00	Jam Nut & Washer Kit for Dexter 9K, 10K & 12K Axles	1-3/4"-12 NF

HUB FASTENERS

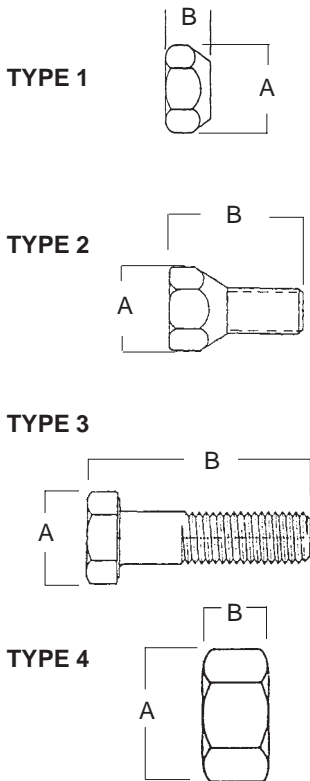

Part No.	Type	Thread	Hex (A)	Height (B)	Description
611-016	1	1/2"-20	13/16"	5/8"	60° Wheel Nut
83922	2	1/2"-20	13/16"	1-5/8"	60° Wheel Bolt
T5793	3	1/2"-13	7/8"	2-1/4"	Mobile Home Bolt
UN-1	4	9/16"-18	7/8"	7/16"	UTG Nut
T5792	3	1/2"-13	7/8"	1-5/8"	Mobile Home Bolt
T5790	5	-	-	-	Mobile Home Rim Clamp
T5791	3	1/2"-20	7/8"	1-7/8"	Mobile Bolt

