

LIGHTS AND ACCESSORIES

LED STOP, TURN & TAIL LIGHTS



LED MULTI-FUNCTION STOP, TURN & TAIL LIGHTS. Submersible, 100,000 hour rated life.
M840 LED Stop, Turn & Tail Light w/o License Illuminator
M840L LED Stop, Turn & Tail Light w/ License Illuminator



LED ROUND 4" SEALED TAIL LIGHTS & ACCESSORIES
24471-R3 Round 4" 7-Diode LED Stop, Turn & Tail Light
24426-18 Round 4" Grommet
B417-49 Molded Plug Connector
426-09 Mounting Bracket



LED 6" OVAL SEALED TAIL LIGHTS & ACCESSORIES
24420R-3 6" Oval 7-Diode LED Stop, Turn & Tail Light
 Includes two lead wires and ground wire w/#10 ring terminal
24421-18 6" Oval Grommet
421-09 Mounting Bracket

LED CLEARANCE & MARKER LIGHTS



2-1/2" RECTANGLE LED SEALED CLEARANCE SIDE MARKER OR IDENTIFICATION LIGHT
24153A Amber LED Clearance/Marker Light
24153R Red LED Clearance/Marker Light
150-095 Black Mounting Bracket
B153-49 Molded Connector Plug



3-13/16" RECTANGLE LED SEALED CLEARANCE SIDE MARKER OR IDENTIFICATION LIGHT
24161A Amber LED Clearance/Marker Light
24161R Red LED Clearance/Marker Light
24154-11K Mounting Bracket & Plug



2-1/2" ROUND LED SEALED CLEARANCE/MARKER LIGHT
24172A Amber LED Sealed Clearance/Marker Light
24172R Red LED Sealed Clearance/Marker Light
24142-18 2-1/2" Flush Mount Grommet
24143-18 2-1/2" Recess Mount Grommet



2" ROUND LED SEALED CLEARANCE/MARKER LIGHT
24174A Amber LED Sealed Clearance/Marker Light
24174R Red LED Sealed Clearance/Marker Light
24146-18 2" Flush Mount Grommet



COMBINATION TAIL LIGHTS

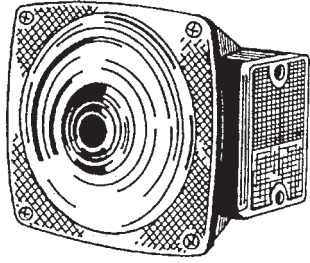

COMBINATION LIGHT. Molded housings will never corrode. Combination lights perform seven different functions; stop, tail, turn signal, rear reflector, side marker light, side marker reflector, and license illuminator. Lights supplied with no splice push-in contacts. Height 4-1/2"; length 5"; depth 2-7/8". For matching clearance marker lights, use M114A/R.

- | | | |
|---------------|----------------------------------------------|--------------------------|
| 24440 | Stop-Tail-Turn Light w/o License Illuminator | Bulk packaged 48 per box |
| 24440L | Stop-Tail-Turn Light w/ License Illuminator | Bulk packaged 48 per box |
| LENS: | 440-15 Stop and Tail | Packaged 10 per box |
| | 55-15R Red Side Marker | Packaged 10 per box |
| | 55-15A Amber Side Marker | Packaged 10 per box |
| BULB: | W1157 Stop and Tail | |
| | W1895 Side Marker | |



OVER 80" WIDE COMBINATION LIGHTS. Includes the following functions; stop, turn, tail, rear reflex, side marker, side reflex and license (L suffix only)

- | | |
|--------|----------------------------|
| 24444 | W/O License Light |
| 24444L | W/ License Light |
| 440-15 | Lens for Stop & Tail Light |
| 56-15R | Lens for Side Marker |

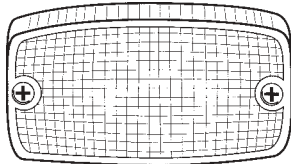

STYLIZED STOP, TURN, AND TAIL LIGHT. Stylized Lexan lens features pillow optics for maximum light dispersion. Height 2-1/2"; length 4-9/16"; depth 1-3/4".

- | | | |
|--------------|----------------------------|--------------------------|
| M306R | Red Stop-Tail-Turn Light | Bulk packaged 48 per box |
| LENS: | 306-25R Special Order only | |
| BULB: | W2057 | |

SUBMERSIBLE LIGHTS

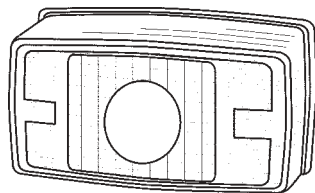

SUBMERSIBLE COMBINATION LIGHT. Low profile rectangular styling utilizing the proven "Bell Jar" concept, with a sliding frame to make bulb replacement easy. Performs functions of stop, turn, tail, rear reflector, clearance, side reflector, side marker, and license illuminator. Height 3-9/16"; length 6-1/8"; depth 2-7/8".

- | | | |
|---------------|----------------------------------------|--------------------------|
| M451 | Stop-Tail-Turn w/o License Illuminator | Bulk packaged 48 per box |
| M451L | Stop-Tail-Turn w/ License Illuminator | Bulk packaged 48 per box |
| LENS: | Not Available | |
| BULBS: | W1157 Stop and Tail | W168 Side Marker |

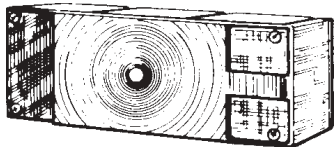

SUBMERSIBLE "OVER 80" TAIL LIGHT. "Over 80" Tail Lights are designed especially for low profile custom boat trailers and snowmobile trailers. These versatile submersible units serve seven basic functions; tail light, stop light, turn signal, side and rear (red) reflex reflector, red side marker light, and red rear clearance light. Pre-installed 15" pigtailed make wiring both fast and simple. These lights can be either flush or recessed mounted. Left hand model has built in license plate illuminator. Color is matte black. Height 2-7/8"; length; 8"; depth 2-3/4". For matching clearance marker light, use #3141.

- | | | |
|-----------------|--------------------------------|--------------------------|
| #3504 | 8-Way Tail Light LH | Bulk Packaged 50 per box |
| #3554 | 7-Way Tail Light RH | Bulk Packaged 50 per box |
| LENS: | #3336 Tail Light & Side Marker | Packaged 24 per box |
| CAPSULE: | #3348 Illumination Capsule | Packaged 6 per box |

STOP & TAIL LIGHT

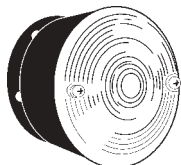

3-3/4" diameter wrap-over lens retained by two screws. Depth 2-5/8". Dust-tight, water-tight construction. Bonderized heavy gauge steel housing finished with baked black enamel. Highly efficient illuminator lens. Mounts with two 1/4" studs on 2" centers. No license illuminator.

- | | | |
|---------------|---------------------|--------------------------|
| 24428S | Stop and Tail Light | Bulk packaged 60 per box |
| LENS: | V420-15 Red Lens | Packaged 12 per box |
| BULB: | W1157 | |



FLUSH MOUNT LIGHT

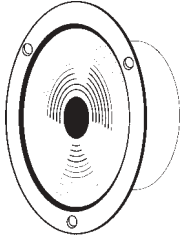

Double wire stop, tail and turn signal. Bonderized steel housing with baked black enamel finish. Standard 4-1/2" diameter lens retained by wire snap ring. Mounting holes on standard 4-7/8" bolt hole circle diameter. Overall mounting depth 1-5/8". Overall diameter is 5-1/2".

M413 Red Flush Mount Tail Turn Light Bulk packaged 48 per box
LENS: V410-15R Two lenses per card Packaged 12 pair per box
BULB: W1157

PEDESTAL MOUNT LIGHT

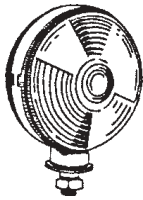

Single Face Mount. Durable, black ABS housing with snap-on red lens. Functions as stop, turn and tail light. Two lead wires exit through 1/2" diameter hollow stud.

313-2 Pedstal Mount Stop Turn Tail Light Bulk packaged 12 per box
LENS: 338-15R (Red) Packaged 12 per box
BULB: W1157

CLEARANCE MARKER LIGHTS

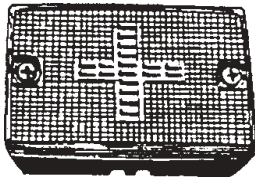

COMBINATION LIGHT. Stud mount side marker or clearance light with built-in reflector optics. Available in red or amber lens with a black housing. Height 2-1/8"; length 2-3/4"; depth 1".

24114A Amber Side Marker Light Bulk packaged 100 per box
24114R Red Side Marker Light Bulk packaged 100 per box
LENS: 55-15A Amber Packaged 10 per box
 55-15R Red Packaged 10 per box
BULB: W194

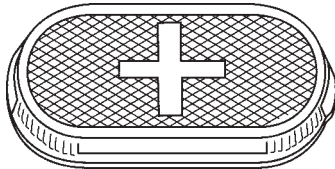

COMBINATION LIGHT. Acrylic lens features built-in reflex reflector and exclusive "cross-optics" for brilliant signal; eliminates separately mounting a reflector. Uses PM's patented VIBAR socket to prolong bulb life. Mounts with two screws on 3" centers. Height 2"; length 4-1/8"; depth 1-1/32".

24108WA Amber Clearance Light, Single Bulb Bulk packaged 100 per box
24108WR Red Clearance Light, Single Bulb Bulk packaged 100 per box
M106A Amber Clearance Light, Double Bulb Bulk packaged 100 per box
M106R Red Clearance Light, Double Bulb Bulk packaged 100 per box
LENS: V108-15A Amber Two Lenses/Card Packaged 6 per box
 V108-15R Red Two Lenses/Card Packaged 6 per box
BULB: W194

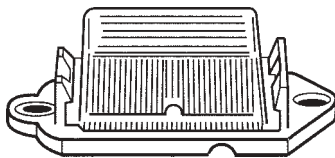

MINI-LITE. Base has external mounting holes with 2-3/4" centers. Acrylic lens locks into base, cannot be knocked out by tree limbs, etc. Height 1"; length 3-1/4"; depth 1-1/8".

M107WA Amber Mini Lite Bulk packaged 100 per box
M107WR Red Mini Lite Bulk packaged 100 per box
LENS: V107-15A Amber Two Lenses/Card Packaged 6 per box
 V107-15R Red Two Lenses/Card Packaged 6 per box
BULB: W194



CLEARANCE MARKER LIGHTS, CONT.

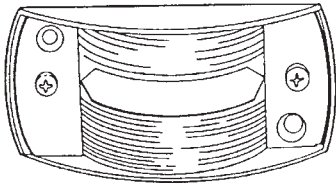

STEEL ARMORED. Acrylic fresnel lens guarded by 14 gauge bright plated steel housing. Mounts without disassembly. VIBAR socket protects bulb filament. Can be spot welded to brackets, beds, etc. Height 2-13/16"; length 4-1/2"; depth 1-1/4".

- M119A** Amber Clearance Light Bulk packaged 48 per box
- M119R** Red Clearance Light Bulk packaged 48 per box
- LENS:** 119-15A Amber Packaged 10 per box
- 119-15R Red Packaged 10 per box
- BULB:** W168

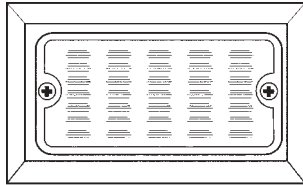

CHROME RECTANGULAR. Deluxe, high-styled features chrome plated housing that will not corrode. Heavy molded vinyl mounting pad seals back of light. Requires a 1" socket mounting hole and flush mounts on 2" centers. Unit grounds through mounting screws. Height 2-1/4", length 3-3/4", depth 1/2".

- M126A** Amber Side Marker Light Bulk packaged 96 per box
- M126R** Red Side Marker Light Bulk packaged 96 per box
- LENS:** 126-25A Amber Packaged 10 per box
- 126-25R Red Packaged 10 per box
- BULB:** W1895

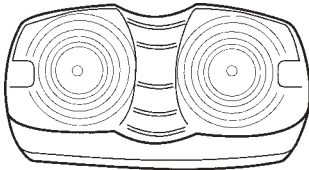

RECTANGULAR TWO BULB. Popular style light has a molded plastic base and two VIBAR sockets for prolonged bulb life. All metal parts are tinned brass. Interchangeable with many similar models.

- M138A** Amber Clearance Marker Light Bulk packaged 100 per box
- M138R** Red Clearance Marker Light Bulk packaged 100 per box
- LENS:** 138-15A Amber Packaged 10 per box
- 138-15R Red Packaged 10 per box
- BULB:** W194

CHROME GUARD



Heavy diecast chrome plated guard for extra protection. Will fit M138R, M138A, M108WA, M108WR, M106A, M106R. Mounts with two screws on 4-3/4" centers. Height 2-3/8", length 5-7/16", depth 1-1/8".

- B106-09** Chrome Guard Bulk packaged 60 per box

IDENTIFICATION LIGHT BAR



Designed for wide trailers, campers, vans, and trucks. Necessary for trailers 80" or wider. Three Mini Lites on an enameled steel bar. Only 1" wide for mounting in narrow rails; overall length 16-1/2"; depth 1-3/8".

- 24107-3A** Amber Light Bar Bulk Packaged 24 per box
- 24107-3R** Red Light Bar Bulk Packaged 48 per box
- LENS:** V107-15A Amber Two Lenses/Card Packaged 6 pairs per box
- V107-15R Red Two Lenses/Card Packaged 6 pairs per box
- BULB:** W194



Submersible identification bar light for over-80" applications. Black polycarbonate corrosion-proof with three 150 sealed lights attached.

- 24150-3AL Amber Light Bar
- 24150-3RL Red Light Bar

MINI UTILITY / COURTESY LIGHT



MINI UTILITY LIGHT

24434 Chrome-plated brass housing with hooded shield to prevent upward glare

PORCH LIGHTS



EURO-STYLE OVAL PORCH LIGHT

M382C Surface mount porch light or utility lights.
Polar white housing and a durable metal base plate



RECTANGULAR

M385S Surface mount porch light or utility lights. Colonial-White Base

STICK-ON REFLECTORS

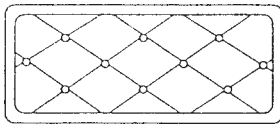

RECTANGULAR. Six segment lens is 3-1/8" by 1-3/8". Adhesive backing mounts on any clean, flat surface.

B483A Amber Reflector

Bulk packaged 100 per box

B483R Red Reflector

Bulk packaged 100 per box



SPITFIRE WIDE ANGLE REFLECTOR. 2-3/4" x 1-3/4" ultra-thin reflector is only .012" thin. New technology provides 47,000 microprisms per square inch. Reflector is hermetically sealed, unbreakable, and mounts on curved surfaces. Adhesive backing mounts on any clean surface.

B489A Amber Reflector Bulk packaged 100 per box

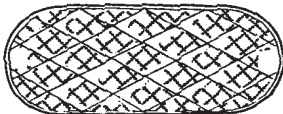

OBLONG QUICK MOUNT. 4-3/8" x 1-7/8" acrylic lens. Adhesive backing permanently mounts reflector to any clean, flat surface.

B480A Amber Oblong Quick Mount Reflector

B480R Red Oblong Quick Mount Reflector

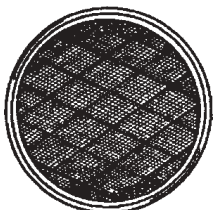

ROUND QUICK MOUNT. 3" diameter acrylic lens. Adhesive backing permanently mounts reflector to any clean, flat surface.

B475A 3" Round Amber Reflector

B475R 3" Round Red Reflector



REFLECTIVE TAPE

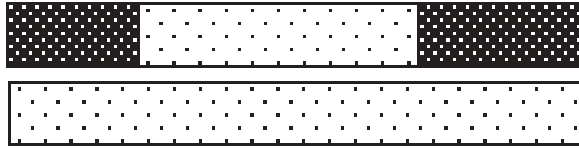
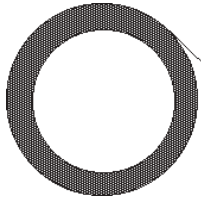

REFLECTIVE TAPE. Microprismatic reflective tape has 160 times magnification of ordinary glass bead sheeting. This results in four-times greater reflectivity, wider viewing angles, higher visibility at long range and greater, tougher durability. Tape is rated at over 1000 candlepower per square foot. It is molded reflector strip - not just reflective tape. It mounts on flat or curved surfaces. It has an industrial strength adhesive for easy and permanent installation. Retro-fitting existing equipment may result in reduced insurance rates. Tape is 2 inches wide. Rolls are 150' long. Sold by the roll or by the strip, see below.

CONSPICUITY TAPE

PART NUMBER	DESCRIPTION
845702	11" Red / 7" White 2" x 150' Roll - 7 Year Warranty
845704	11" Red / 7" White 2" x 150' Roll - 3 Year Warranty
845705	6" Red / 6" White 2" x 150' Roll - 3 Year Warranty
845708	11" Red / 7" White 2" x 150' Roll Precut 18" - 3 Year Warranty
845709	6" Red / 6" White Pre-Cut Every 12" 2" x 150' Roll - 3 Year Warranty
845724	White 2" x 150' Roll Precut 12" - 7 Year Warranty

NHTSA SUGGESTED RETROFIT PATTERN

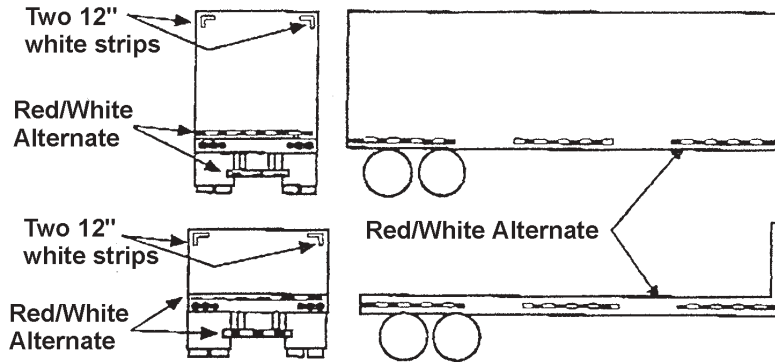

Affects all trailers 10,000 lbs GVW and over 80" overall width, except trailers designed exclusively for living or office use. Effective 12/01/93, OE only.

Side Application

- 2" wide red/white alternate strips of tape must run a minimum of 50% the length of the trailer.

Rear Application

- 2" wide red/white tape to span the rear of the trailer
- 2" wide red/white tape on the horizontal bar of the rear I.C.C. bumper
- A pair of 2" wide, 12" long white tape strips in the upper rear corners



SEALED LIGHTS

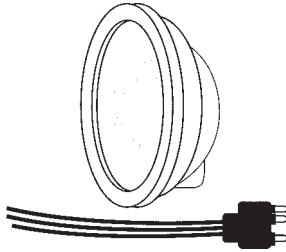

4" COMPLETE SEALED LIGHT KIT. Includes 24431 double filament sealed unit, 24426-18 mounting grommet and 24431-491 plug. Replaces Truck-Lite 40002.

24431KR Red Flush Mount Stop, Turn & Tail Light Kit
Packaged 48 per Box

24431KA Amber Turn Signal Light Kit

426-09 Mounting Bracket
Bulk Packaged 6 per Box

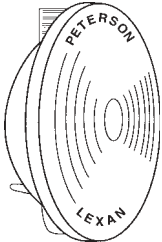
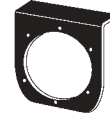

4" SEALED LIGHT. Housing and lens are permanently sealed to eliminate corrosion. The bulb is cradled in PM's patented VIBAR II socket which literally floats the bulb filaments soaking up road shock and vibration. Lexan lens and housing eliminate distortion due to heat. Use with plug 431-491 for a completely weather-tight electrical connection. Replaces Truck-Lite 40202.

24431A Amber Stop, Turn & Tail Light **426A-24V** Amber Light Only
24431R Red Stop, Turn & Tail Light **426R-24V** Red Light Only
24431C Clear Backup Light
Packaged 12 per Box

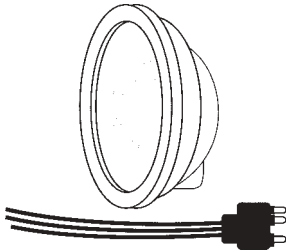

4" COMPLETE SEALED LIGHT KIT. Includes 427 double filament sealed unit with reflector optics, 426-18 mounting grommet and 431-491 plug. Eliminates mounting and maintaining separate rear reflectors.

427KR Red Flush Mount with Reflector Stop, Turn & Tail Light Kit
Bulk Packaged 12 per Box

426-09 Mounting Bracket
Bulk Packaged 6 per Box

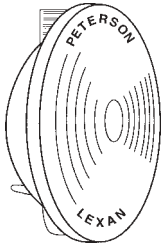
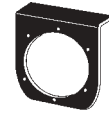

4" SEALED LIGHT. Same quality features as our 426 series with the addition of reflector optics around the periphery of the lens. Eliminates mounting and maintaining separate rear reflectors. Use with plug number 431-491 for a completely weather-tight electrical connection.

M427R Red Stop, Turn & Tail Light with Reflector
Bulk Packaged 12 per Box

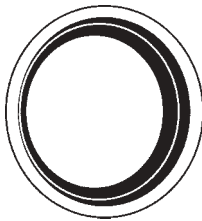

MOUNTING GROMMET. Ultraviolet resistant PVC material for long life. Designed to mount in a 4-1/2" diameter hole when used with plate thickness of .125 to .1875. Other recommended hole sizes are: plate thickness .0625 - hole diameter 4.47 inch; plate thickness .25 - hole diameter 4.53 inch; plate thickness .375 - hole diameter 4.56 inch. Replaces Truck-Lite 40700.

24426-18 Black Grommet for 426 and 427 Series
Packaged 12 per Box



CONNECTOR PLUG. Three wire (one tail light, one turn signal, one ground) plug. Replaces Truck-Lite 94926 and 94933.

24431-491 Three Wire Plug for 416, 421, 426 & 427 Series
Packaged 12 per Box

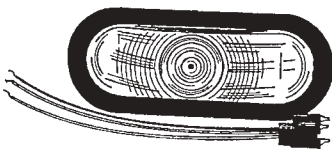

OVAL SEALED COMPLETE LIGHT KIT. Includes 421 double filament sealed unit, 421-18 mounting grommet, and 431-491 plug.

24421KR Red Flush Mount Stop, Turn & Tail Light Kit
24421KA Amber Flush Mount Turn Signal Light Kit
24416K White Flush Mount Back Up Light
Packaged 12 per Box

421-09 Mounting Bracket
Bulk Packaged 6 per Box





SEALED LIGHTS, CONT.

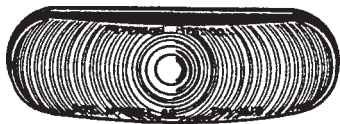

OVAL SEALED LIGHT. Housing and lens are linearly welded to provide a permanent seal. Unit is legal in either the vertical or horizontal mounting position. Wedge based bulb is protected from vibration with PM's patented VIBAR socket. A 421-18 grommet and 431-491 plug are required to complete installation. Amber unit 421A functions as a combination parking and turn signal. Height 2-1/4"; length 6-1/2"; depth 2-3/8".

- | | | |
|---------------|------------------------------------------|---------------------|
| 24421A | Amber Combination Parking and Turn Light | Packaged 48 per Box |
| 24421R | Red Stop, Turn & Tail Light | Packaged 48 per Box |
| 24416 | White Backup Light | Packaged 48 per Box |

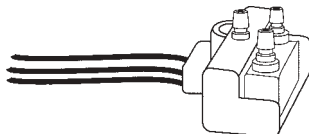

CONNECTOR PLUG. Right angle, three wire plug with an added terminal for all double filament bulbs. For use with 416 and 421 series lights.

- | | | |
|------------------|----------------------------|---------------------|
| 24421-491 | Right Angle Connector Plug | Packaged 10 per Box |
| 24441-49 | Right Angle Two-Wire Plug | |

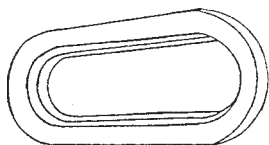

MOUNTING GROMMET. Ultraviolet resistant PVC material for long life. To be used with 416 or 421 series sealed lights. Replaces Truck-Lite 60700.

- | | | |
|-----------------|-------------------------------|---------------------|
| 24421-18 | Black Grommet for Oval Lights | Packaged 12 per Box |
|-----------------|-------------------------------|---------------------|

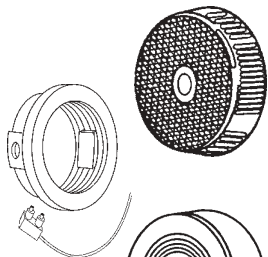

2 1/2" SEALED LIGHT. Lens and housing sonically welded into a sealed unit that will meet all requirements for a combination clearance or marker lamp and reflector. Replaces Truck-Lite 10205. The grommet kit below is necessary to mount the M143A and M143R. Depth 3/4".

- | | | |
|------------------|-------------------------------------------------------------|----------------------|
| 24143A | 2-1/2" Amber Clearance Light | Packaged 100 per Box |
| 24143R | 2-1/2" Red Clearance Light | Packaged 100 per Box |
| 24142-18K | Recessed Mount Grommet Kit. Requires a 3" mounting hole. | Packaged 12 per box. |
| 24143-18K | Flush Mount Grommet Kit. Requires a 2-25/32" mounting hole. | Packaged 12 per box. |
| 24142-49 | Plug Only | Packaged 100 per box |

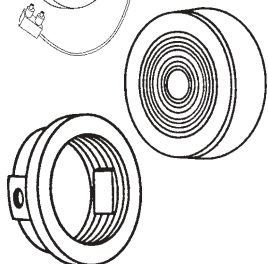

2" SEALED LIGHT. Lexan lens and housing sonically welded into a single unit for maximum service and protection. Requires a B146-18 grommet (below) and B142-49 plug (above) to complete installation. Replaces Truck-Lite 30200. Depth 3/4".

- | | | |
|-----------------|--------------------|----------------------|
| 24146A | Amber Sealed Light | Packaged 100 per Box |
| 24146R | Red Sealed Light | Packaged 100 per Box |
| 24146-18 | Grommet & Plug Kit | Packaged 100 per Box |

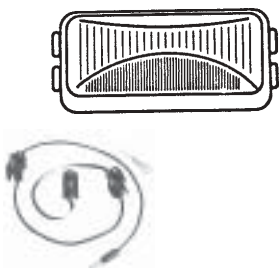

SEALED LIGHT. Lexan lens and housing sonically welded into a single unit for maximum service, with mounting tabs for easy installation. Requires a 150-09 mounting bracket and B142-49 plug (see above). Mounting bracket is made of molded ABS material in gray finish and includes two screws.

- | | | |
|----------------|---------------------------------------|----------------------|
| 24150A | Amber Sealed Light | Packaged 100 per Box |
| 24150R | Red Sealed Light | Packaged 100 per Box |
| M150C | Clear Sealed Light | Packaged 100 per Box |
| 150-09 | Gray Mounting Bracket | Packaged 12 per Box |
| 150-092 | Black Self-Grounding Mounting Bracket | Packaged 12 per Box |

3-PLUG PIG TAIL. Identification light bar sealed wire harness.

150-49	3 Plug Pig Tail	Packaged 12 per box
---------------	-----------------	---------------------



3-13/16" SEALED LIGHT. Rectangle Clearance/Marker Lights

- | | |
|---------------|-------|
| 24154A | Amber |
| 24154R | Red |

FENDER MOUNT CLEARANCE LIGHT. Functions as both amber front clearance light and a red clearance light for over 80" trailers.

- | | |
|------------------|-------------------------|
| V154A-R | Amber & Red. |
| 24154-11K | Mounting Bracket & Plug |



RV REPLACEMENT LIGHTS



RV STOP, TURN & TAIL LIGHT W/REFLEX.
 Surface mount rear combination tail light.
V25911 Red - Stop, Turn & Tail Light
V25912 Red - Stop, Turn & Tail Light with back up light

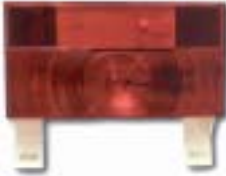

RV STOP, TURN & TAIL LIGHT W/REFLEX.
 Surface mount rear combination tail light with license plate bracket
V25913 Red - Stop, Turn & Tail Light with license plate bracket
V25914 Red - Stop, Turn & Tail Light with back up light and license plate bracket



RV STOP, TURN & TAIL LIGHT W/REFLEX.
 Surface mount rear combination tail light.
V25921 Red - Stop, Turn & Tail Light
V25922 Red - Stop, Turn & Tail Light with back up light



RV STOP, TURN & TAIL LIGHT W/REFLEX.
 Surface mount rear combination tail light with license plate bracket.
V25923 Red - Stop, Turn & Tail Light with license plate bracket
V25924 Red - Stop, Turn & Tail Light with back up light and license plate bracket

INTERIOR LIGHTS

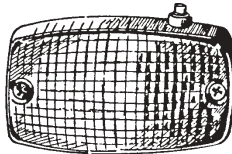

INTERIOR DOME LIGHT. Surface mount interior light features a durable Lexan lens and nylon switch for long life. Wedge base bulb cushioned in a VIBAR socket. Unit mounts on 3-1/2" centers and a separate ground wire is supplied. Height 1-3/4", Length 4-9/16", Depth 1-3/4".
24391 Interior Dome Light Bulk packaged 48 per Box

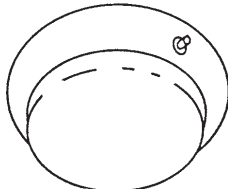

INTERIOR DOME LIGHT. Corrosion resistant, high impact plastic light with built-in push on/off switch. Translucent white lens provides diffused light ideal for general illumination. Grounds through mounting screws. Diameter 6-5/16", Depth 2".
V390S Interior Dome Light Bulk packaged 48 per Box

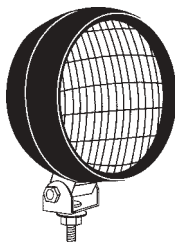

FLOOD LIGHT KIT. Durable, molded weatherproof housing cushions par 36 sealed beam from road shock and vibration. Universal, 5/16" stud and adjustable, zinc-plated bracket allow mounting in any position. Halogen flood beam.
24507F Flood Light Kit Packaged 12 per box



LICENSE PLATE LIGHTS

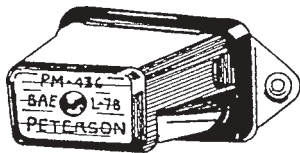

LICENSE PLATE LIGHT. Lexan housing retained with a stainless steel screw. VIBAR socket protects fragile bulb filament from road shock and vibration. All internal parts are stainless steel or brass. Mounting holes on 3-1/2" centers. Height 1-3/4"; overall length 4"; overall depth 2-3/4".

24X436 License Plate Light Bulk packaged 48 per box

LENS: 436-25

BULB: W168

HOUSING: 436-01

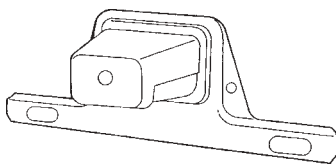

LICENSE PLATE LIGHT WITH BRACKET. License plate light riveted to a heavy gauge bonderized steel bracket finished in baked black enamel. Bracket features 1/4-20 SAE locking weld nuts on 7" centers. Surface mounting, supplied with screws for mounting license plate. Installs without disassembly with two mounting holes on 3-1/2" centers.

24X436B License Plate Light w/Bracket Bulk packaged 24 per box

436911 Mounting Kit for 24X436B

LENS: 436-25

BULB: W168

HOUSING: 436-01

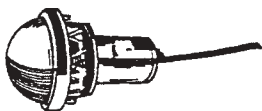

SNAP-IN LICENSE/UTILITY LIGHT. Chrome plated steel light snaps into 1-1/4" diameter hole, overall diameter is 1-1/2". Ideal for courtesy, interior, instrument and license lights. Two units required for legal license illumination.

438 Snap-In License/Utility Light Bulk packaged 24 per box

BULB: W97



CHROME PLATED LICENSE PLATE LIGHT.

Mounts on 2" centers and grounds through mounting screws.

435 Chrome Plated License Plate Light

LICENSE PLATE BRACKET

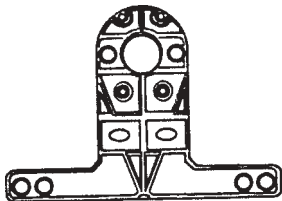

Tough molded, black ABS bracket will never rust or corrode. Designed for use with all PM and Wesbar tail lights.

24440-09 License Plate Bracket Bulk packaged 24 per box



SPOT MIRRORS

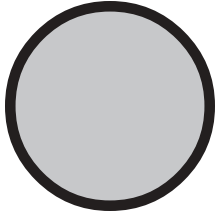

BLIND SPOT MIRRORS. Convex glass, molded, black corrosion-free housing. Weather-resistant adhesive back sticks to any clean, flat surface.

V600 2" Diameter Round Blind Spot Mirror

V603 3" Diameter Round Blind Spot Mirror

V603L 3-3/4" Diameter Round Blind Spot Mirror. 3-5/8" reflective area.

CLEAR DRIVING LIGHT KIT

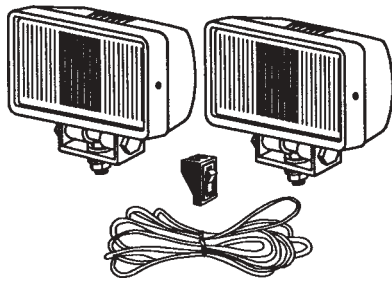

SPORT AND UTILITY. Designed and built for the popular sport and utility vehicles of today. Housings constructed of durable ABS material. Complete unit features hardened glass lenses, strong mounting brackets and powerful 55-watt halogen bulbs. Kit contains 2 lights, rocker switch, wiring, all connectors and easy to follow instructions. Designed for use above or below bumper mount.

V568-1 Clear Driving Light Kit

ELECTRONIC FLASHERS

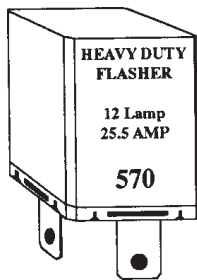

ELECTRO-MECHANICAL FLASHERS. Two prong, 12 lamp flashers with an amp rating of 25.2 with a 70-120 flash rate.

V570 Electro-Mechanical Flasher.

Only 1-1/2" tall, this unit fits in small areas with limited access. Packaged 6 per Box.

TRAILER LIGHT KIT

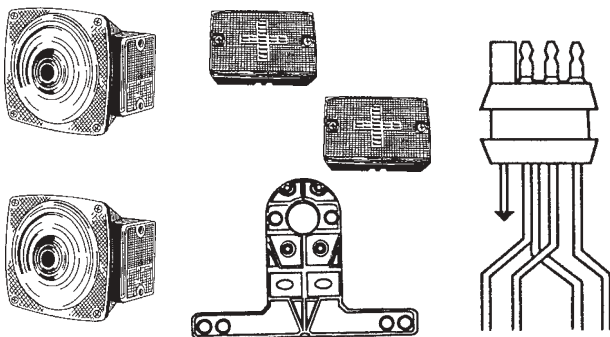

24440KIT Light Kit with Wire

Contains:

- 1) 24440 Stop-Tail-Turn Light
- 1) 24440L Stop-Tail-Turn Light with License Plate Illuminator
- 2) 24114A Amber Side Marker Stud Mount
- 1) 24440-09 License Plate Bracket
- 1) B3425Y 25' Wishbone Trailer Harness



POLLAK CONNECTORS

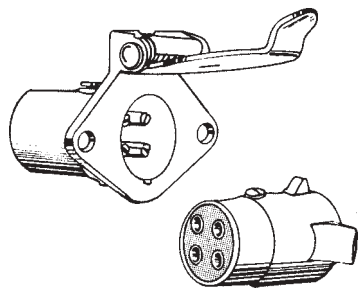

PART NO.	DESCRIPTION
11-410	4-Way Socket, Tow Vehicle End Only, Bulk Pack.
11-409	4-Way Plug, Trailer End Only, Bulk Pack
11-408V	4-Way Complete Assembly, Tow Vehicle and Trailer Ends, Vis-Pack C/R 643-150 Dorman

Polarized, chrome plated housing and spring loaded cover. High impact green Cylolac insulators and split brass contacts. Mounting holes 1-3/4" on centers.

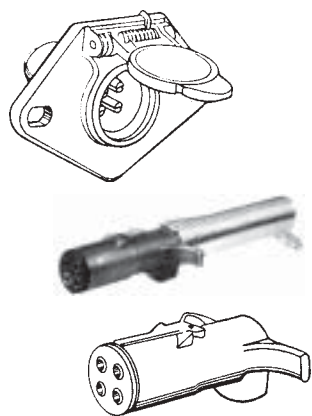

11-404V	4-Way Socket, Tow Vehicle End Only, Vis-Pack
11-402	4-Way Plug, Trailer End Only
11-403	4-Way Plug w/Spring Cable Guard, Trailer End Only, Bulk Pack.
11-400V	4-Way Complete Assembly, Tow Vehicle and Trailer Ends, Vis-Pack.

Die cast design. Extended socket exterior conceals terminals. Unique cable clamp prevents chafing - gives more cable support, saves installation time. Integral finger grips for positive pull. Stainless steel spring. Dust and water resistant. Polarized.

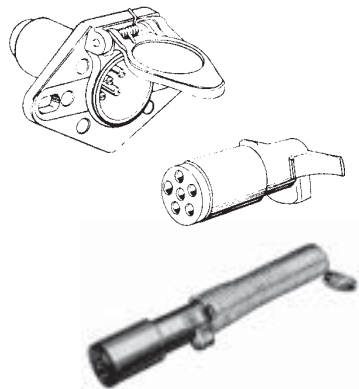

11-609	6-Way Socket, Tow Vehicle End Only, Bulk Pack
11-609V	6-Way Socket, Tow Vehicle End Only, Vis-Pack
11-604	6-Way Plug, Trailer End Only, Bulk Pack
11-604V	6-Way Plug, Trailer End Only, Vis Pack
11-605	6-Way Plug w/Spring Cable Guard, Trailer End Only, Bulk Pack
11-603V	6-Way Complete Assembly, Tow Vehicle and Trailer Ends, Vis-Pack, C/R 643-151 Dorman

Heavy duty 6-Way die cast connector with rugged Cylolac interiors. Unique cable clamp gives more support and helps save installation time. Concealed terminal socket design, stainless steel spring. Unit is dust and water resistant.

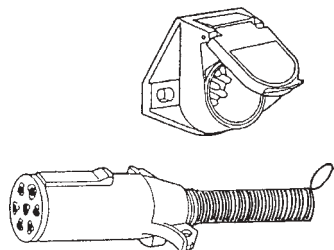

11-721V	7-Way Socket, Round Post Type, Tow Vehicle End Only, Zinc Die Cast
11-702V	7-Way Plug with Spring Cable Guard, Trailer End Only, Zinc Die Cast Housing



POLLAK CONNECTORS, CONT.

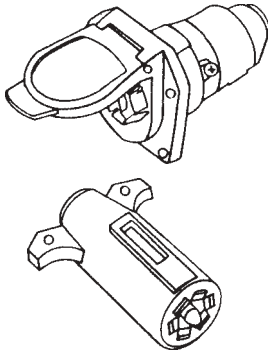

PART NO.	DESCRIPTION
12-707	7-Way Socket, Tow Vehicle End Only, Bulk Pack
12-707V	7-Way Socket, Tow Vehicle End Only, Vis-Pack
12-706	7-Way Plug, Trailer End Only, Bulk Pack
12-706V	7-Way Plug, Trailer End Only, Vis-Pack
12-705V	7-Way Complete Assembly, Tow Vehicle and Trailer Ends, Vis-Pack

Black Polla Plas construction. Eliminates rusting, poor appearance and difficulty in plug removal. New design offers dual grips for ease of removal of plug from socket and incorporates vinyl inserts to keep out dirt and moisture. Interior design prevents internal short-circuiting and the safety latch prevents damage from accidental pull-away. Color coded to RVI standards - and interchangeable with other well-known RV types. Detailed instructions permit use for both 6- and 7-way applications.

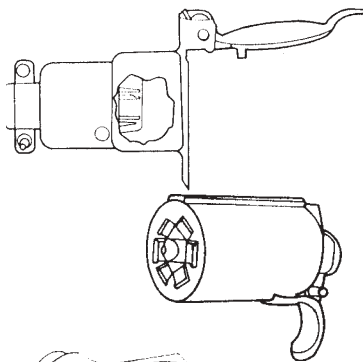

12-703	7-Way Socket, Tow Vehicle End Only, Bulk Pack.
12-703V	7-Way Socket, Tow Vehicle End Only, Vis-Pack
12-702	7-Way Plug, Trailer End Only, Bulk Pack
12-702V	7-Way Plug, Trailer End Only, Vis-Pack
12-700V	7-Way Complete Assembly, Tow Vehicle and Trailer Ends, Vis-Pack

Steel construction, heavily plated for maximum weather and corrosion resistance, self-wiping pressure contacts. Stainless steel cover spring. Jumbo welded pistol grip. Unique safety latch prevents damage from accidental pull-away. Specially designed vinyl inserts keep out dust and moisture. Color coded to RVI standards. Detailed instructions permit use for both 6- and 7-way applications.

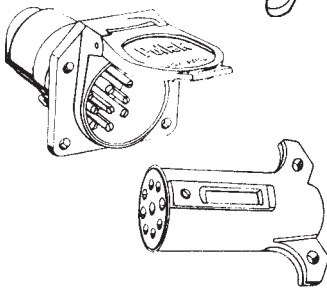

12-907V	9-Way Heavy Duty RV Socket, Tow Vehicle End Only, Vis-Pack
12-906V	9-Way Heavy Duty RV Plug, Trailer End Only, Vis-Pack

Black Polla Plas construction. Longer terminal pins guarantee maintaining engagement. No possibility of molding compound contaminating contact to cause "dead spots." Unique method of machining from solid bar (not stamping) and spring loading contact give long trouble-free service. "Floating Pins" are self-aligning offering continuous wiping action and the most positive contact. Terminals are one piece construction for best conductivity. Designed for 2-8 gauge, 2-12 gauge, and 5-14 gauge. New applications require 12 volt, nothing less. Contacts on both trailer and tow vehicle side spring loaded. Completely field serviceable.

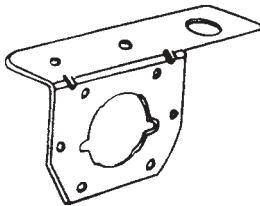

11-617	Universal Connector Bracket. Designed to fit under trailer tongue, ball or 2-hole frame mounting. Heavy duty steel, cadmium plated. Fits connectors 404, 11-404V, 11-400V, 11-410, 11-408V, 609, 11-609V, and 11-603V. Bulk Pack.
11-617V	Universal Connector Bracket, fits above applications, Vis-Pack.

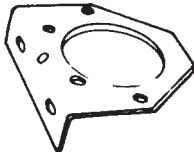

11-771V	7-Way Connector Bracket, for 7-Pole ATA Connectors. Fits connector 721, Vis-Pack (Can also be used with 404, 11-404V, 11-400V, 609, 11-609V, 11-603V)
---------	-------------------------------------------------------------------------------------------------------------------------------------------------------

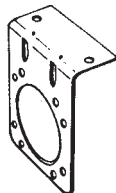

12-701	Right Angle Mounting Bracket constructed of heavy gauge steel. Fits 12-703, 12-703V, 12-700V, 12-707, 12-707V, and 12-907V, Bulk Pack.
12-701V	Right Angle Mounting Bracket, fits above applications, Vis-Pack

WIRE HARNESSES AND CONNECTORS

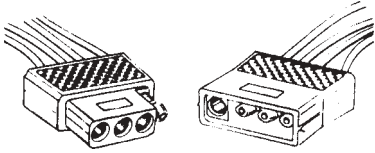

12-403 Pollak 4-Way Connector. Flat Type, 18 Gauge Wire, 12" long.
Includes Tow Vehicle & Trailer ends.

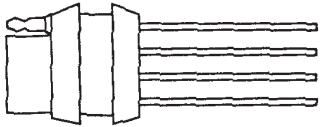

B3400B Peterson Trunk Connector. Four foot trunk connector with 48" ground wire conforms to all SAE standards. Color coding is: white - ground; brown - tail lights, side markers, clearance lamps; yellow - left turn and stop; green - right turn and stop. Bulk Packaged 100 per box.

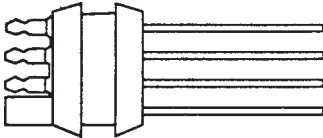

B3425 Wunside Trailer Harness by Peterson. Contains only the 25' Wunside Trailer Harness with a flat-4 plug. Bulk packaged 50 per box.

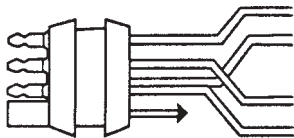

B3425Y Wishbone Trailer Harness by Peterson. Contains only the 25' Wishbone Trailer Harness with a flat-4 plug. Bulk Packaged 50 per box

WIRE HARNESSES AND CONNECTORS, CONT.

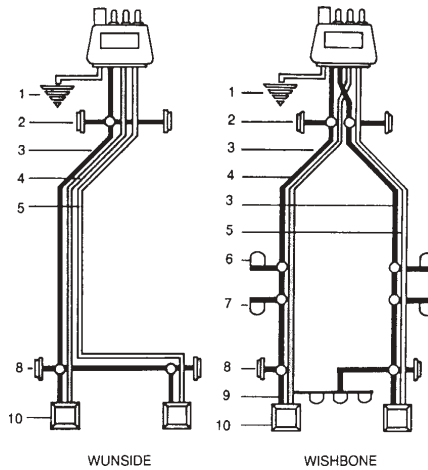

COLOR CODINGS. The Wishbone and Wunside Trailer Harnesses are color coded for uniformity to SAE and TMA standards. Connect **yellow** to left turn signal and stop wire in the left rear of trunk... **green** to right turn and stop...**brown** to tail light wire...and **white** to frame or body of car for ground.



White	-	Ground	Brown	-	Tail Lights
Yellow	-	Left Turn and Stop	Brown	-	Side Markers
Green	-	Right Turn and Stop	Brown	-	Clearance Lights

TRAILER DIAGRAM. The following apply to Wishbone and Wunside Trailer Harnesses.

- | | |
|-----------------------------------------|--------------------------------|
| 1. White Wire - ground to trailer frame | 6. Clearance Lamps (Amber) |
| 2. Side Marker Lights (Amber) | 7. Clearance Lamps (Red) |
| 3. Brown Wire | 8. Side Marker Lights (Red) |
| 4. Yellow Wire | 9. I.D. Light Bar (Red) |
| 5. Green Wire | 10. Tail, Stop, and Turn Light |

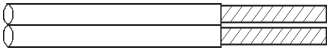
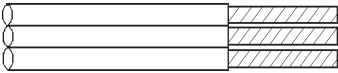

TRAILER WIRE AND CABLE

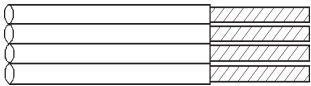
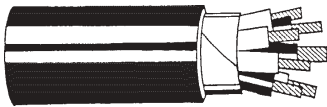
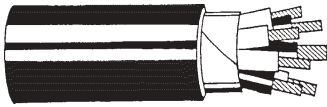
	PART NO.	DESCRIPTION
	16-2	Double Wire. SAE general purpose primary wire bonded together in two conductors in a ripcord manner. Color coded red and black. 16 gauge; 12,500 ft/roll; sold per foot.
	16-3	Triple Wire. SAE general purpose primary wire bonded together in three conductors in a ripcord manner. Color coded brown, yellow, and green. 16 gauge; sold per roll of 1000'.
	30848	Duplex Primary Wire. Has an extra tough polyvinyl jacket extruded over GPT insulated primary wire. The inside conductors are color coded white and black. The outer jacket is gray. Recommended where wire must withstand extreme abrasion or for trailer brakes. 14 gauge; 1000 ft./roll; sold per foot.
	16-4	Four Conductor Primary Wire. Primary wire designed especially for RV's and trailers. Color coded white, brown, yellow, and green. 16 gauge, 500 ft./roll; sold per foot.
	7228	6-Way Trailer Cable. Made with a new plastic outer jacket that remains flexible at very low temperatures. The inside conductors are made to SAE specifications. Color coded red, white, black, brown, green, and yellow for identification purposes. 14 gauge, six conductor. Jacket color is black. Spool size is 2000 feet; sold per foot.
	C560H	7-Way Trailer Cable. Made with a new plastic outer jacket that remains flexible at very low temperatures. The inside conductors are made to SAE specifications. Color coded red, white, black, brown, green, yellow and blue for identification purposes. 14 gauge, six conductor. Jacket color is black. Spool size is 500 feet; sold per foot.

PRIMARY WIRE

Flexible copper conductor, insulated.

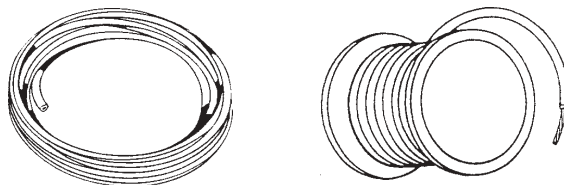

GAUGE	14	16
LENGTH	1000' Roll	1000' Roll
COLOR	PART NO.	PART NO.
RED		116MR
BLACK		116MBLK
BLUE	114MBLU	
YELLOW		116MY
GREEN		116MG
BROWN		116MBRN
WHITE		116MW



SPADE TERMINALS

Vinyl insulated with color coded sheeve.

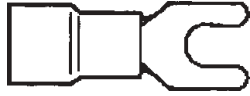

PART NO.	GAUGE	STUD SIZE	COLOR	PACKAGE QTY
A2S-6	22-18	#6	Red	100
A2S-8	22-18	#8	Red	100
A2S-10	22-18	#10	Red	100
B2S-6	16-14	#6	Blue	100
B2S-8	16-14	#8	Blue	100
B2S-10	16-14	#10	Blue	100
B2S-14	16-14	1/4"	Blue	100
C2S-8	12-10	#8	Yellow	100
C2S-10	12-10	#10	Yellow	100
C2S-14	12-10	1/4"	Yellow	100

RING TERMINALS

Vinyl insulated with color coded sheeve.

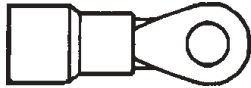

PART NO.	GAUGE	STUD SIZE	COLOR	PACKAGE QTY
A2R-8	22-18	#8	Red	100
A2R-10	22-18	#10	Red	100
A2R-14	22-18	1/4"	Red	100
A2R-56	22-18	5/16"	Red	100
B2R-10	16-14	#10	Blue	100
B2R-14	16-14	1/4"	Blue	100
B2R-56	16-14	5/16"	Blue	100
B2R-38	16-14	3/8"	Blue	100
C2R-10	12-10	#10	Yellow	100
C2R-14	12-10	1/4"	Yellow	100
C2R-56	12-10	5/16"	Yellow	100
C2R-38	12-10	3/8"	Yellow	100



BUTT CONNECTORS

Plastic insulated with color coded sheeve.



PART NO.	GAUGE	COLOR	PACKAGE QTY.
A2B	22-18	Red	100
B2B	16-14	Blue	100
C2B	12-10	Yellow	100

FEMALE SLIDE CONNECTOR

Plastic insulated with color coded sheeve.

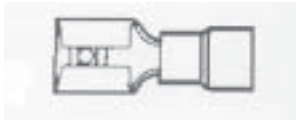

PART NO.	GAUGE	TAB SIZE	COLOR	PACKAGE QTY.
B2FE-250	16-14	1/4"	Blue	100

SELF STRIPPING QUICK CONNECTORS

Plastic insulated copper wire connector.



PART NO.	GAUGE	COLOR	PACKAGE QTY.
SL-B3M	16-14	Blue	100

CRIMPER



PART NO.	DESCRIPTION	QTY
CR-3	General purpose crimper. Cuts wire, crimps insulated terminals & strips wire.	1

